

ROUGH COUNTRY

SUSPENSION SYSTEMS®



1333BAG2

2012-18 DODGE 1500 4" LIFT KIT W/ STRUTS

Thank you for choosing Rough Country for all your suspension needs.

Rough Country recommends a certified technician install this system. In addition to these instructions, professional knowledge of disassemble/reassembly procedures as well as post installation checks must be known. Attempts to install this system without this knowledge and expertise may jeopardize the integrity and/or operating safety of the vehicle.

Please read instructions before beginning installation. Check the kit hardware against the kit contents list. Be sure you have all needed parts and know where they go. Also please review tools needed list and make sure you have the tools needed to install the kit.

⚠ WARNING

Generally, braking performance and capability are decreased when larger/heavier tires and wheels are used. Take this into consideration while driving. Do not add, alter, or fabricate any factory or after-market parts to increase vehicle height over the intended height of the Rough Country product purchased. Mixing component brands is not recommended. Seat belts and shoulder harnesses should be worn at all times. Avoid situations where a side rollover may occur.

Rough Country makes no claims regarding lifting devices and excludes any and all implied claims. We will not be responsible for any product that is altered. We will be happy to answer any questions concerning the design, function, and use of our products.

⚠ NOTICE

This 4" suspension system was developed using a 35 X 12.5 tire with aftermarket wheels. 20" wheels with 5 1/2" backspace or an 18" wheel with 5" of backspace will be required to maintain adequate clearance. Stock wheels can be used with this lift with the addition of a 1/4" wheel spacer. As with any tire and wheel combination it is recommended to trial fit the tire / wheel to assure there are no clearance problems.

⚠ NOTICE

Please note, this lift kit is not recommended for AWD (All Wheel Drive) Models. TRX models will achieve approximately 1" of additional lift. This lift is not recommended for use on the TRX models due to possible CV shaft vibration caused by the additional lift. Instead, consider our 4" lift system for about 5" of lift or replace the TRX struts with standard struts for use with this system.

⚠ NOTICE

NOTICE TO DEALER AND VEHICLE OWNER

Any vehicle equipped with any Rough Country product should have a "Warning to Driver" decal installed on the inside of the windshield or on the vehicle's dash. The decal should act as a constant reminder for whoever is operating the vehicle of its unique handling characteristics.

Tools Needed:

WD-40	16mm Socket / Wrench
Loc-Tite	17mm Socket / Wrench
Reciprocating Saw	18mm Socket / Wrench
Hammer	19mm Socket / Wrench
Dead Blow Hammer	21mm Socket / Wrench
T30 Torx head bit	22mm Socket / Wrench
5mm Allen Wrench	24mm Socket / Wrench
8mm Socket / Wrench	35mm Socket
10mm Socket / Wrench	1 1/16" Socket
13mm Socket / Wrench	Strut Compressor
14mm Socket / Wrench	
15mm Socket / Wrench	

Torque Specs:

Size	Grade 5	Grade 8
5/16"	15 ft/lbs	20 ft/lbs
3/8"	30 ft/lbs	35 ft/lbs
7/16"	45 ft/lbs	60 ft/lbs
1/2"	65 ft/lbs	90 ft/lbs
9/16"	95 ft/lbs	130 ft/lbs
5/8"	135 ft/lbs	175 ft/lbs
3/4"	185 ft/lbs	280 ft/lbs
Class 8.8	Class 10.9	
6MM	5 ft/lbs	9 ft/lbs
8MM	18ft/lbs	23 ft/lbs
10MM	32ft/lbs	45ft/lbs
12MM	55ft/lbs	75ft/lbs
14MM	85ft/lbs	120ft/lbs
16MM	130ft/lbs	165ft/lbs
18MM	170ft/lbs	240ft/lbs

KIT CONTENTS

1332Box1 Containing:

1-Fr Cross-member
1-Rr Cross-member

1332Box2 Containing:

1-Dr Fr Diff Brkt
1-Dr Rr Diff Brkt
1-Pass Diff Brkt
1-Skid Plate
1-Fr Driveshaft Spacer
2-Fr Sway Bar Brkt
2-Fr Sway Bar Link
1-Dr Fr Brake Brkt
1-Pass Fr Brake Brkt

1333Box2 Containing:

2-Rr Brake Brkt
2-Rr Bumpstop Brkt
2-Rr Shock Flagnut
2-Rr Coil Spacers
2-Rr Coil Retainers

1380Box1 Containing:

1-Dr Knuckle

1380Box2 Containing:

1-Pass Knuckle

(2) 23008 Lifted Struts

1329Bag1 Containing

For Front and Rear Cross-Members:

4-18mm x 150mm Bolt
4-18mm Lock Nut
8-Square Washers

1332Bag2 Containing:

For Rear Upper Driver Diff Mount:

3-12mm x 45mm Bolts
3-Flat Washers
3-12mm Flange Lock Nuts

For Front Upper Driver Diff Mount:

2-12mm x 45mm Bolts
2-Flat Washers
2-12mm Flange Lock Nuts

For Passenger Side Diff Mount:

2-12mm x 45mm Bolts
2-12mm Flange Lock Nuts
2-Flat Washers

For Drive Shaft Spacer:

4-12mm x 55mm Bolts

For Front Skid Plate:

4-3/8" x 1" Bolts
4-Flat Washers
2-3/8" Lock Nuts

For Front Brake Lines Brackets:

2-5/16" x 3/4" Bolts
2-5/16" Flange Lock Nuts
2-Flat Washers
2-3/8" x 1" Bolt
2-3/8" Flange Lock Nuts

For Front Sway Bar Links:

2-12mm x 35mm Bolts
2-12mm x 50mm Bolts
4-12mm x 65mm Bolts
8-12mm Flange Nuts

1328Bag3 Containing:

For Rear Coil Spacers:

2-3/8" x 3 1/2" Bolts
2-3/8" Lock Nuts

For Rear Bump Stops:

2-3/8" x 1" Bolts
2-3/8" Flange Lock Nuts
2-Flat Washers

For Rear Sway Bar Links:

4-12mm x 65mm Bolts
4-12mm Lock Nuts
8-Flat Washers

For Rear Brake Line Bracket:

2-5/16" x 3/4" Bolt
2-5/16" Flange Lock Nuts
2-Flat Washers

For Rear Vent Hose:

1-Cable Tie

For Rear Shock Absorbers:

2-Washers



KIT CONTENTS



Thank You for choosing Rough Country for your off road needs!!!



INSTALLATION INSTRUCTIONS

1. Chock rear wheels of the vehicle and raise the front of the vehicle using a floor jack.
2. Support the vehicle with jack stands.
3. Remove wheel using 22mm socket.
4. Remove tie-rod end nut using 21mm as shown in **Photo 1**.
5. Strike with hammer to dislodge the tie rod from the knuckle. **See Photo 2**.

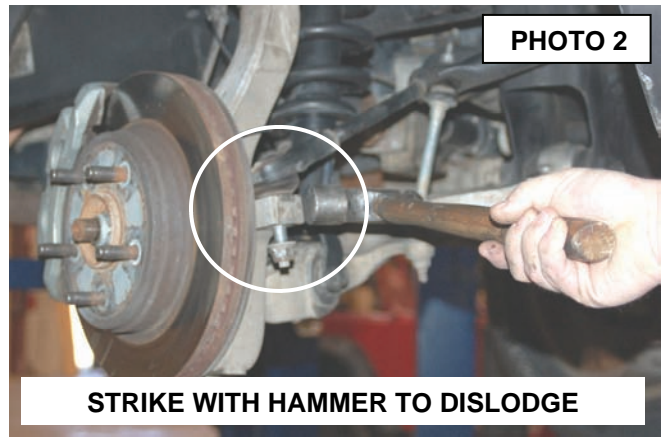
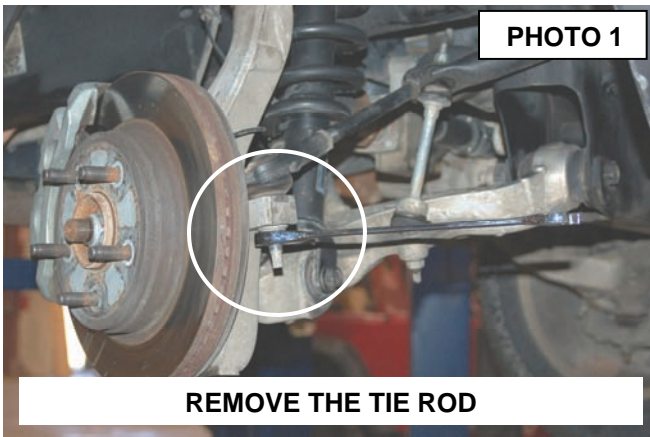

6. Remove brake caliper using 21mm wrench. **See Photo 3**. Secure out of way and remove rotor.
7. Remove ABS wire from hub using 5mm allen wrench, unclip ABS wire from knuckle also. **See Photo 4**.

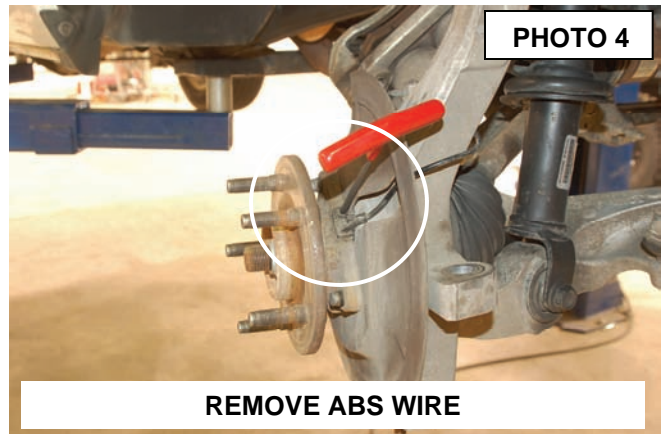
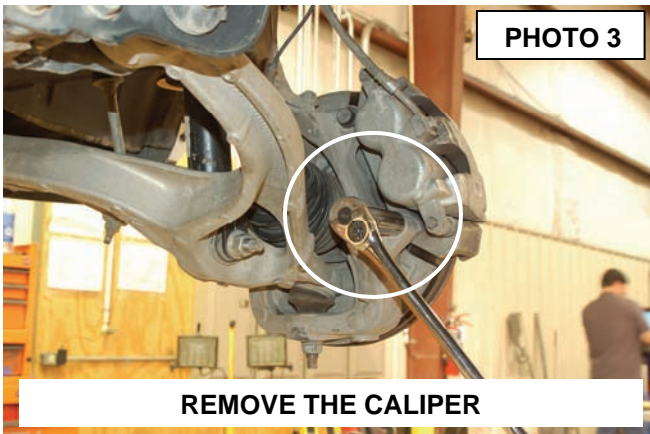

8. Remove axle nut using 35mm socket. **See Photo 5**.
9. Remove knuckle using 21mm wrench for top ball joint and 24mm wrench for lower ball joint. Strike with hammer as shown to dislodge the ball joints. Upper Joint shown in **Photo 6**.

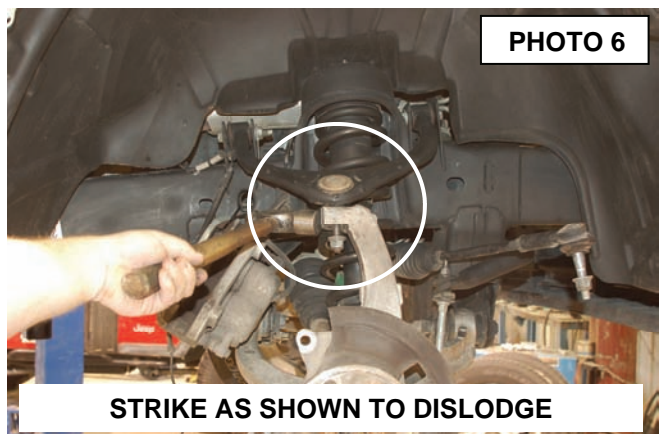

10. Remove the stock knuckle from the truck. **Take care not to allow the shaft to over extend.**

11. Remove lower strut mount using 21mm and 24 mm wrench. **See Photo 7.**

12. Remove sway-bar link from sway-bar using 16mm wrench. **See Photo 8.**

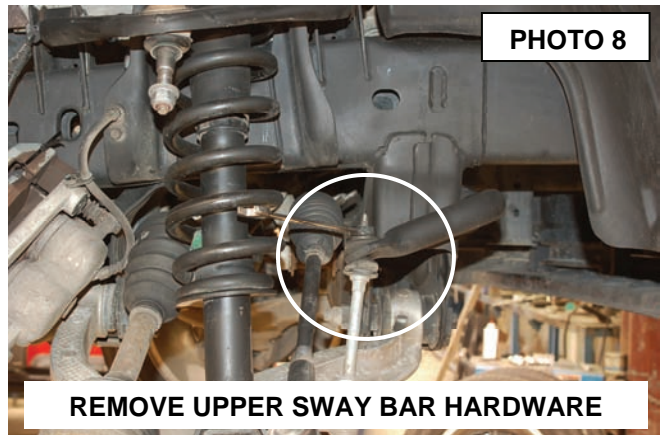
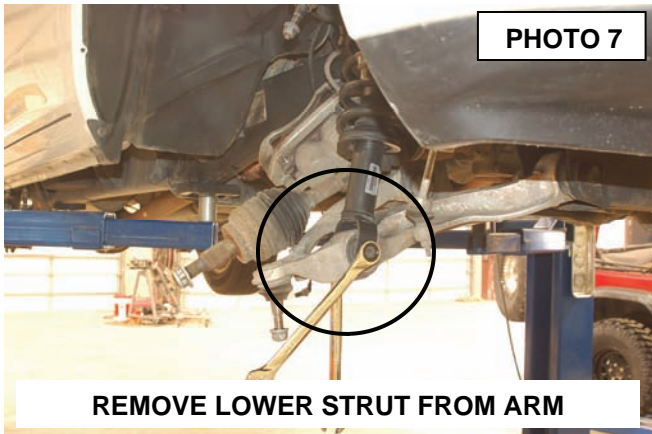

13. Remove upper strut mount using 15mm wrench and remove strut. **See Photo 9.**

14. Using a dead blow hammer remove axle from diff. **See Photo 10.**



15. Using 24mm wrenches remove lower control arm. Retain the stock hardware for reuse. **See Photo 11.**

16. Unplug diff wiring harness from the differential. **See Photo 12.**

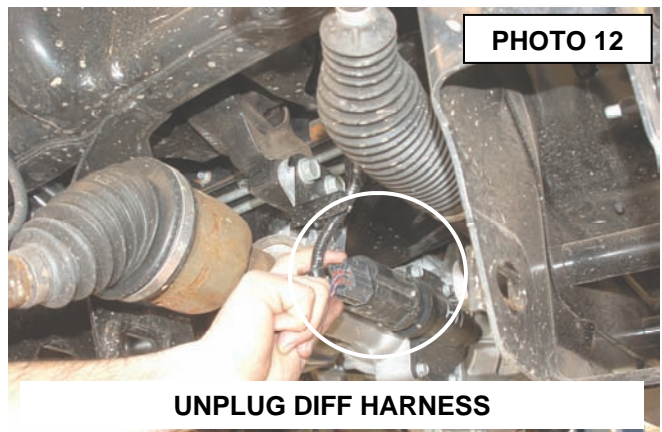
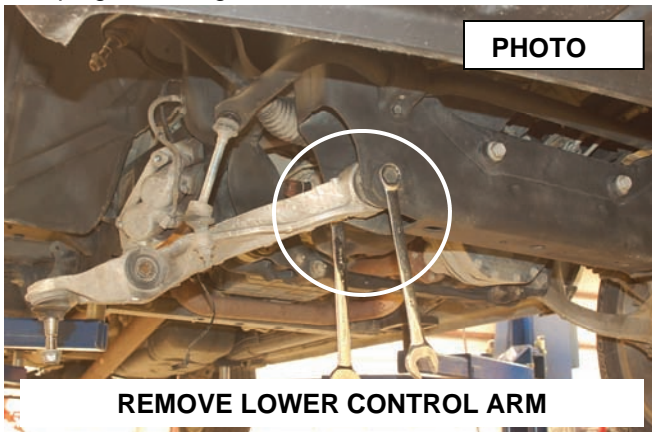

17. Remove the two upper diff bolt from the motor mount / diff mount using 18mm socket. Retain the stock hardware .
See Photo 13.

18. Remove rear cross-member using 18mm wrench. **See Photo 14.**

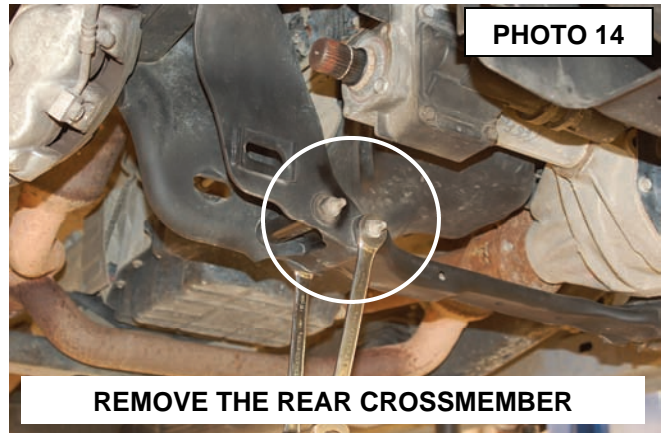
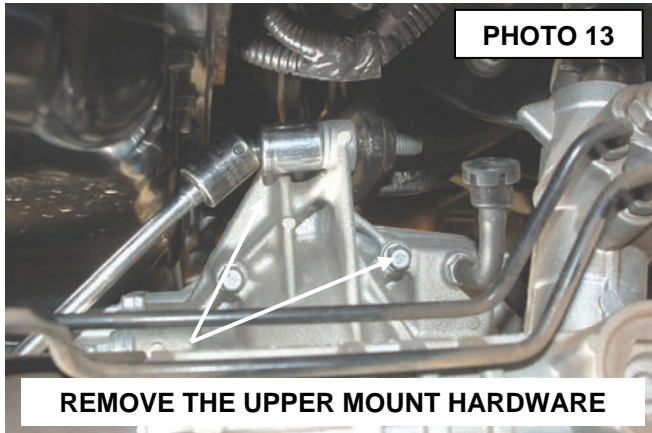

19. Remove driveshaft from diff using 15mm wrench. **See Photo 15.**

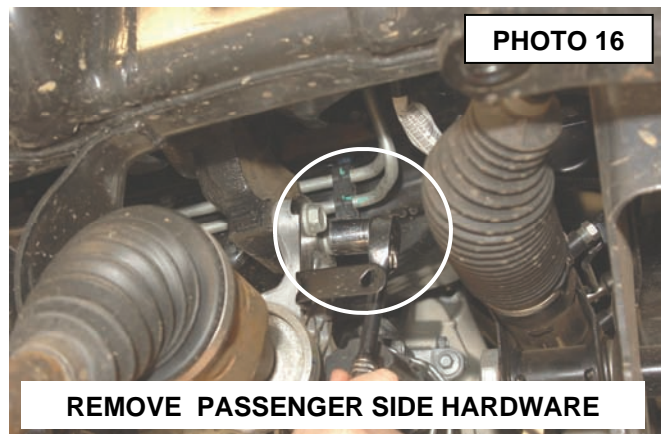
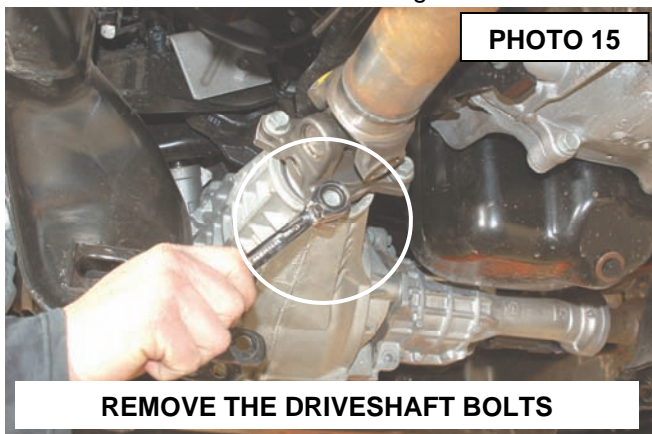

20. Support the diff and remove the passenger side bolts with 18mm wrench and remove the 3 bolts on driver side with same wrenches. **See Photo 16 & 17.**

21. Carefully remove differential from vehicle.

22. Follow the differential wiring harness up from the differential and remove the 3 plastic retainers securing the wiring harness to the frame. **See Photo 18.** This is performed to allow slack in the line when the differential is reinstalled with the differential brackets.

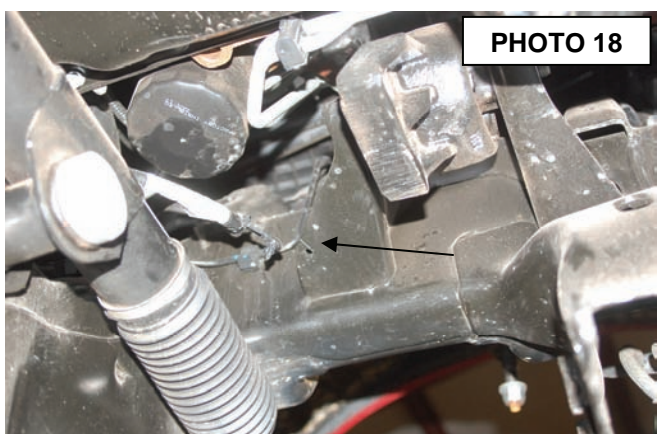
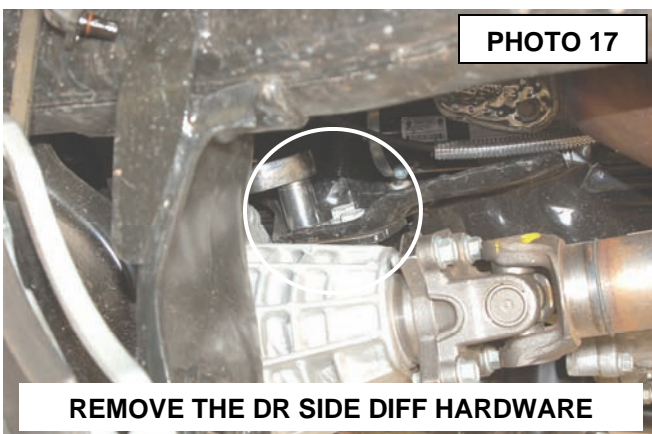

23. Align the supplied template with the lower holes. Tape cut out to driver side lower control arm rear pocket.
 24. Cut at the line on the cut out. this is done to make room for rear cross member. Grind sharp edges and paint. **See Photo 19 & 20.**

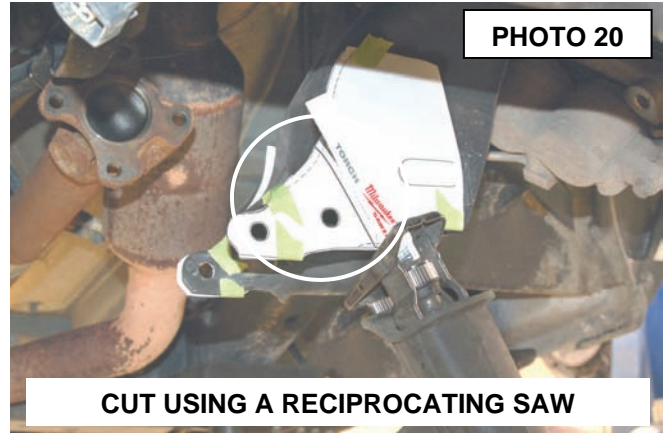
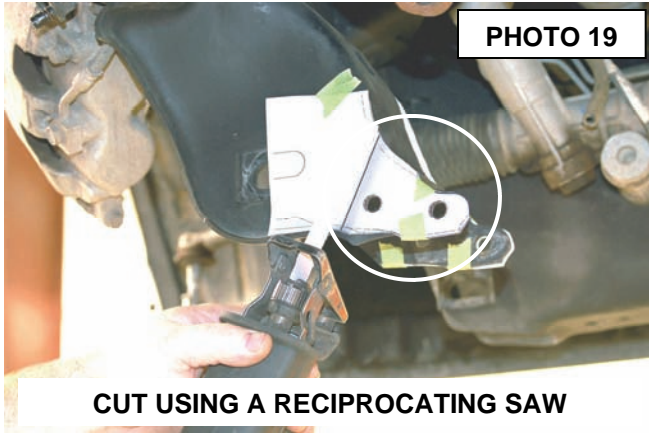

25. Install rear diff drop bracket on the differential using the stock hardware. **See Photo 21.** Tighten using a 18mm wrench.
 26. Install driver side upper diff drop bracket using the stock hardware. **See Photo 22.** Do not tighten at this time.

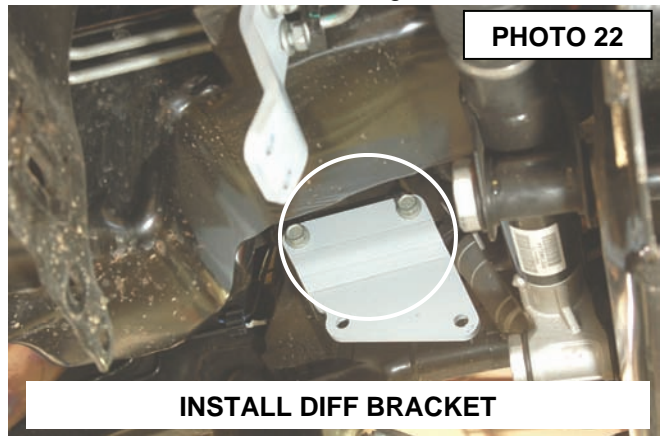
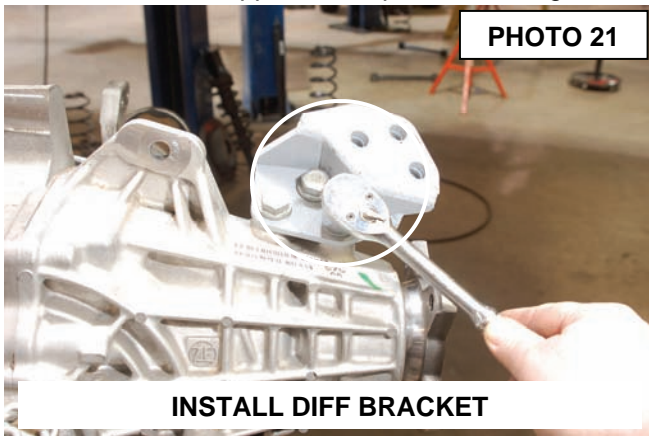

27. Install passenger side diff bracket using stock hardware in upper location making sure the notch goes down. Do not tighten at this time. **See Photo 23.**
 28. Reinstall diff in the forward driver side mount as shown in **Photo 24** using supplied 12mm x 45mm bolts, washers. Do not tighten at this time.

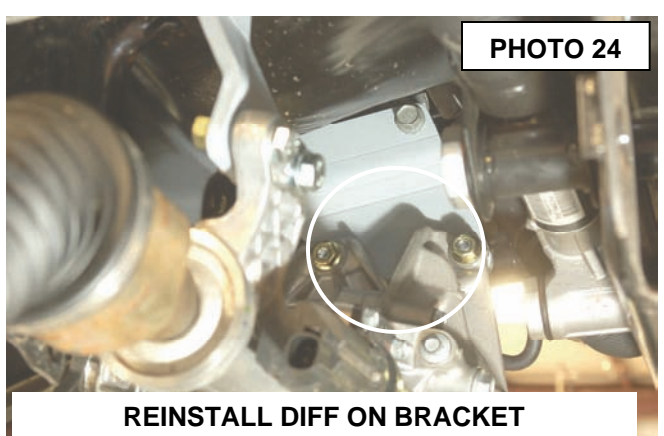
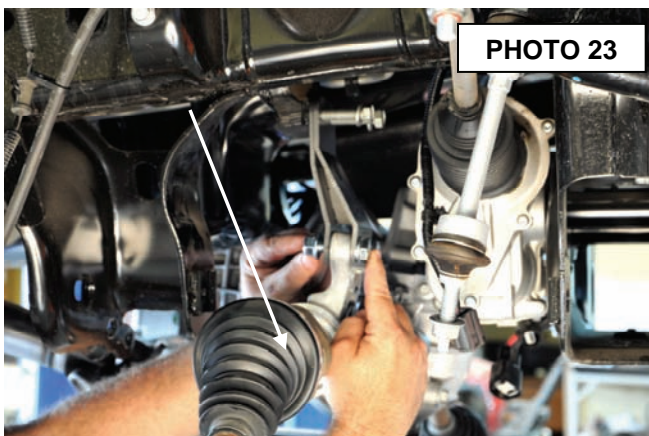

29. Secure the driver side differential to the frame using the supplied 12mm x 45mm bolts, flat washers, and flange lock nuts. **See Photo 25.**
30. Secure the differential in the passenger side bracket using the supplied 12mm x 45mm bolts & flange lock nuts and bend the stock diff wiring harness bracket up for clearance. **See Photo 26.**

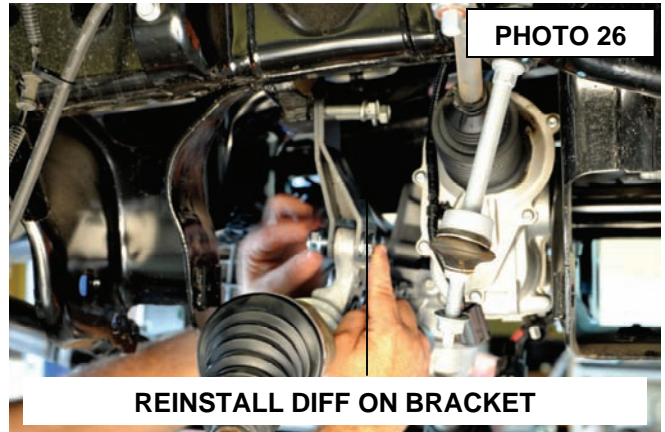
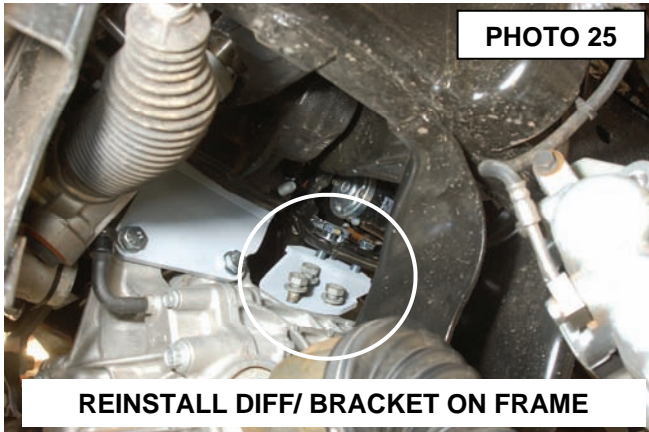

31. Tighten all diff bolts at this time using a 18mm / 19mm wrench.
32. Apply thread lock to supplied 12mm x 55mm bolts and install driveshaft spacer. Use a 19mm wrench to tighten. **See Photo 27.**
33. Reinstall the diff plug back in the differential and reinstall the wiring harness in the bracket. Make sure the wiring harness clears the rack and pinion. **See Photo 28.**

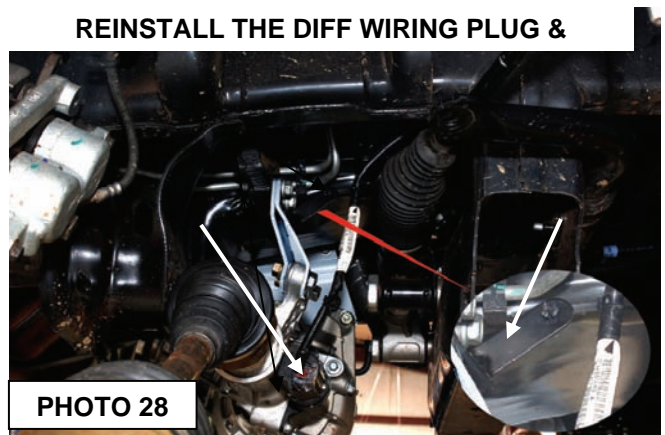
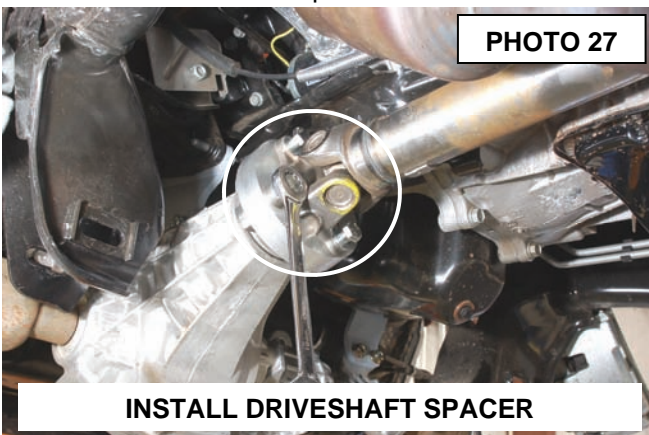

34. Install rear cross member using supplied 18mm x 150mm bolts, square washers and nuts. **See Photo 29.**
35. Install front cross member using supplied 18mm x 150mm bolts, square washers and nuts. **See Photo 30.** Do not tighten at this time.

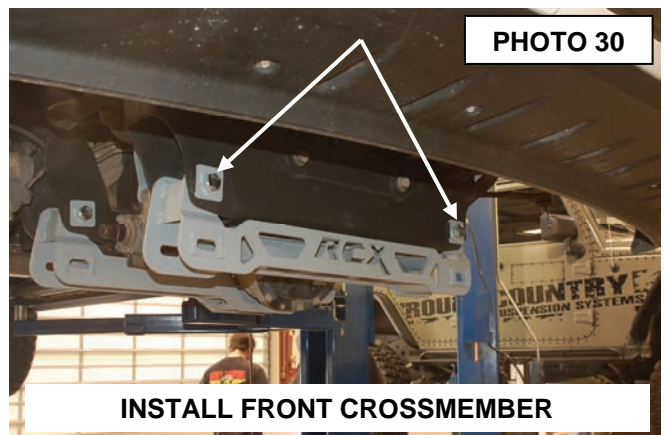
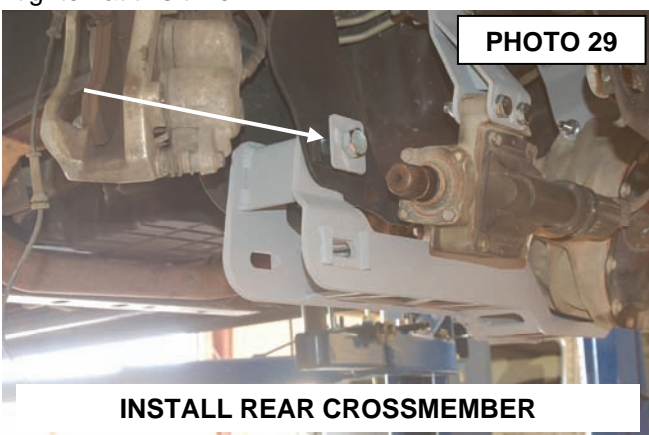

36. Install lower control arm using stock cam bolts. **See Photo 31.**
 37. Install skid plate using supplied 3/8" X 1" bolts, washers, and lock nuts (1332BAG2) on the front cross-member. Use 14mm socket to tighten. **See Photo 32.**

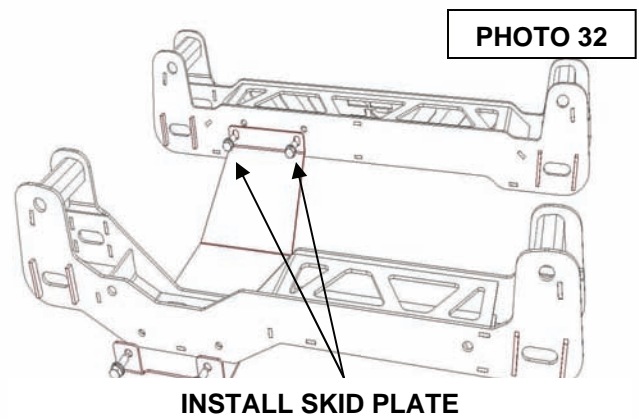
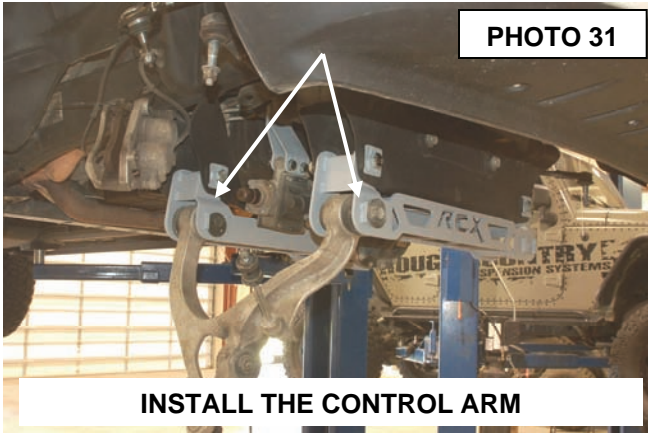

38. Install the skid plate on the rear cross-member as shown in **Photo 33** with the supplied 3/8" x 1" bolts and washers.
 39. Using 1 1/16 wrench and socket tighten cross member bolts. **See Photo 34.**

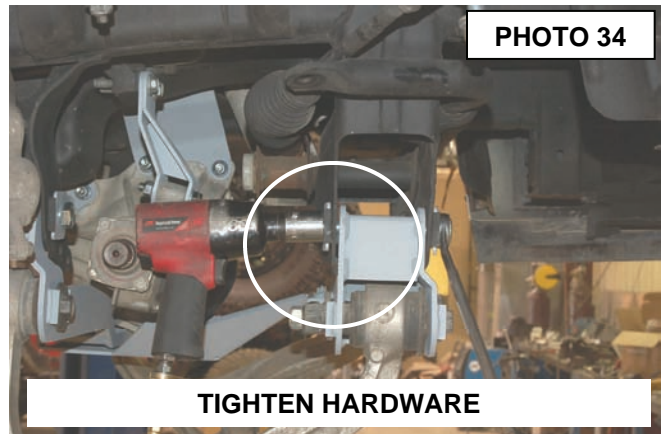
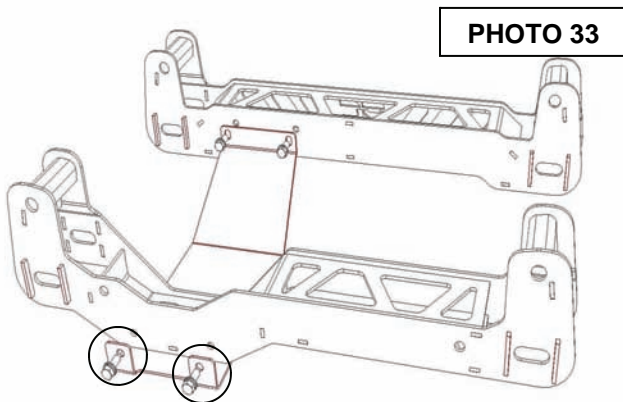

40. Install axle shafts making sure the axle is fully engaged in the housing. **See Photo 35.**
 41. Refer to lifted strut instructions 922300000, then proceed with step 42.

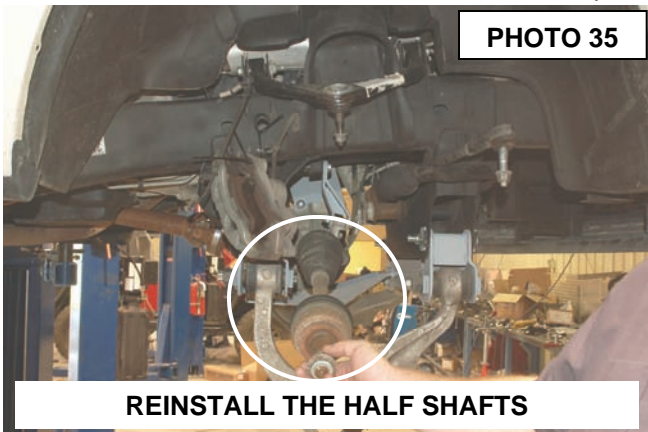

42. Remove sway-bar link from control arm using 18mm and 8mm wrench.
43. Install the lower link bracket on the lower control arm with the supplied 12mm X 45mm bolt and flange nuts. Install the new link on the bracket with the supplied 12mm x 65mm bolts, flat washers and nuts. Tighten using a 18mm and 19mm socket & wrench. **See Photo 36.**

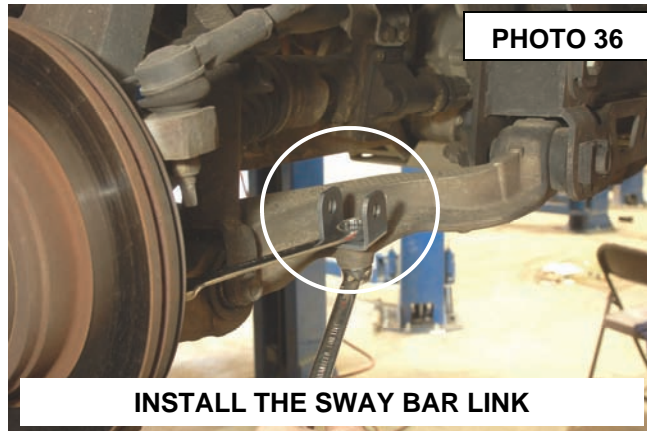

44. Install the sway bar link bracket to the bottom side of the sway bar and tighten with the 12mm x 35mm bolts and flange nut. Tighten using a 18mm and 19mm wrench. Next install the sway bar link to the bracket and tighten using the 12mm x 65mm bolts and flange nuts. **See Photo 37.**
45. Using a 13mm wrench remove bolt from brake line mount and pull brake line out to give clearance for cutting. **See Photo 38.**

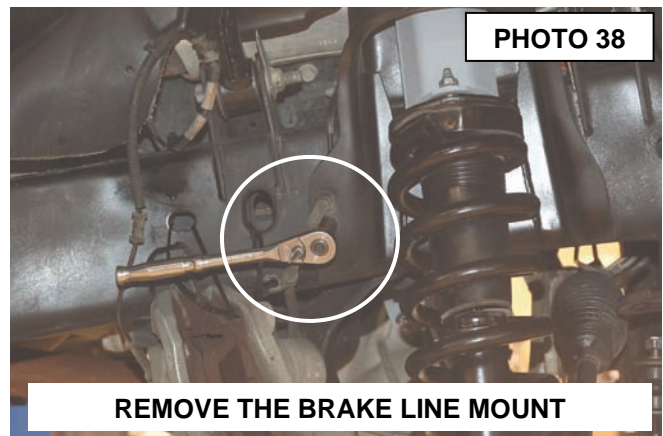
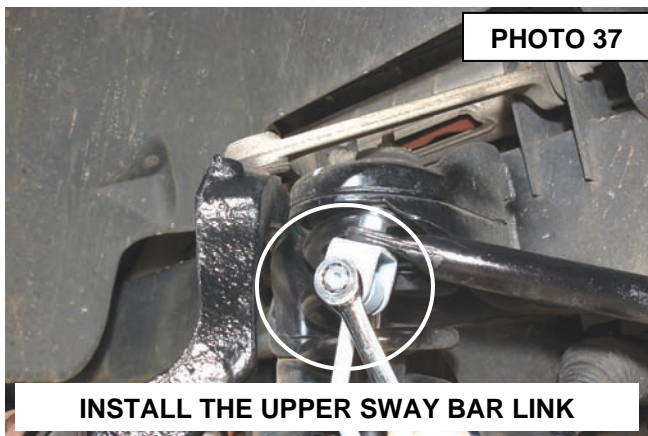

46. Notch a section of the stock mount to remove the brake line as shown in **Photo 39** and remove line from housing. Straighten bends in hard metal lines making sure to not kink lines.
47. Install new brake line bracket onto brake line using supplied 5/16" x 3/4" bolts, washers and nuts. **See Photo 40.**

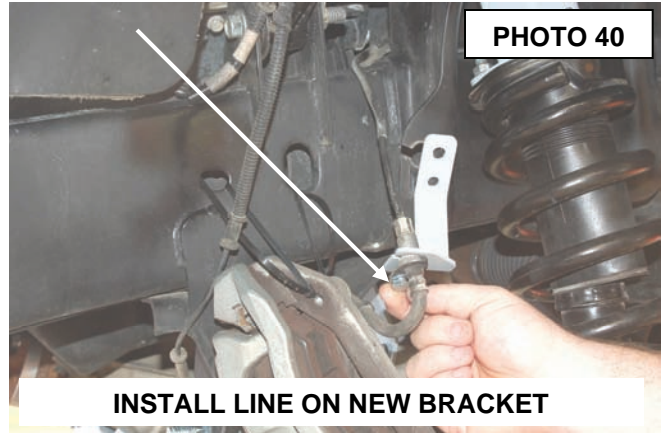
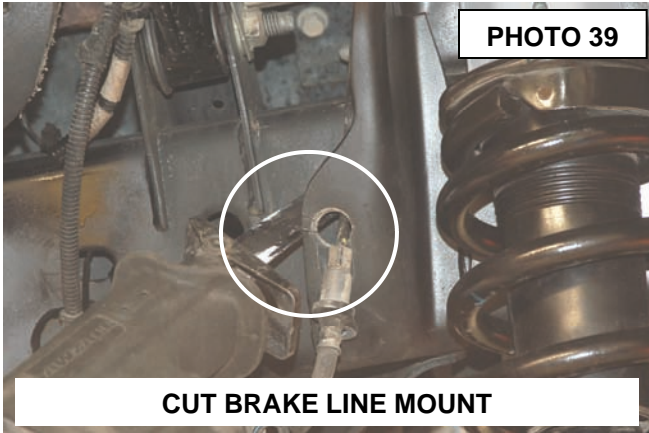

48. Then attach bracket to frame using stock bolt in lower hole and new supplied 3/8" x 1" bolts, washers and nuts. **See Photo 41.** Use a 13mm wrench to tighten stock bolt and lower brake line bolt then use a 14mm on top 3/8" bolt.
49. Remove bearing assembly from the stock knuckle using 18mm socket. **See Photo 42.**

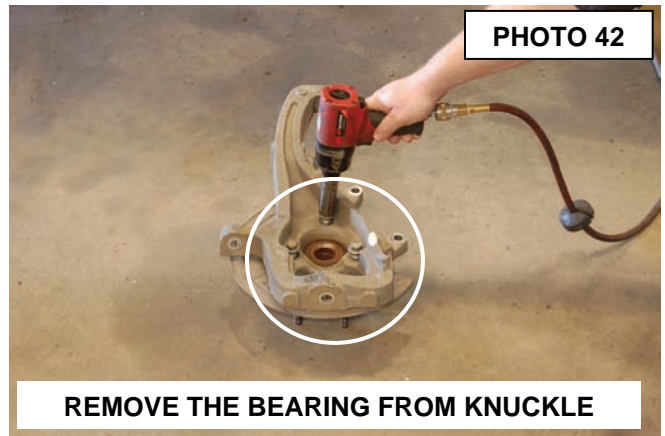
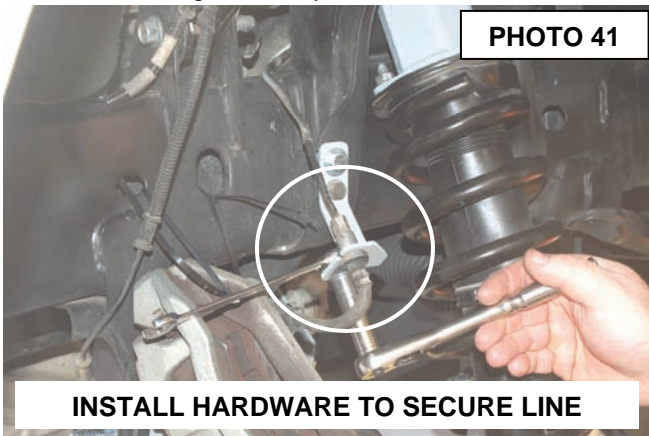

50. Install bearing into new knuckle using stock bolts and a thread locking compound. **See Photo 43.**
51. Install new knuckle onto truck using a 24 and 12mm wrench for lower ball joint. **See Photo 44.**

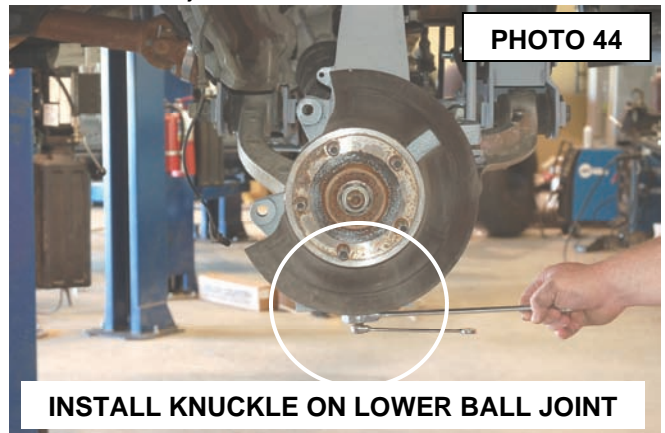

52. Slide the axle in the bearing assembly and install the knuckle on the upper ball joint using a 21mm and 10mm wrench. **See Photo 45.**

53. Tighten the axle nut using a 35mm socket. **See Photo 46.**

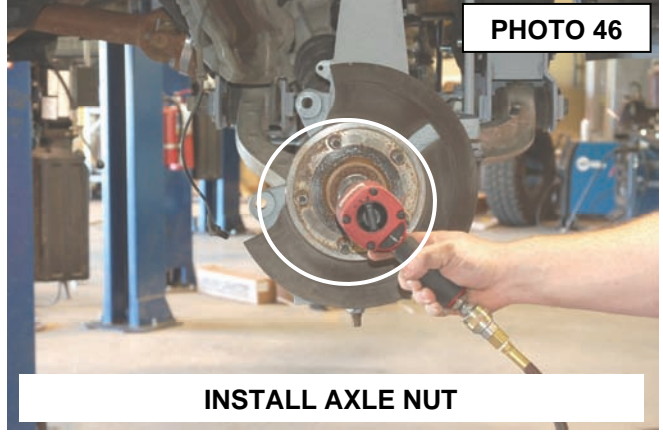
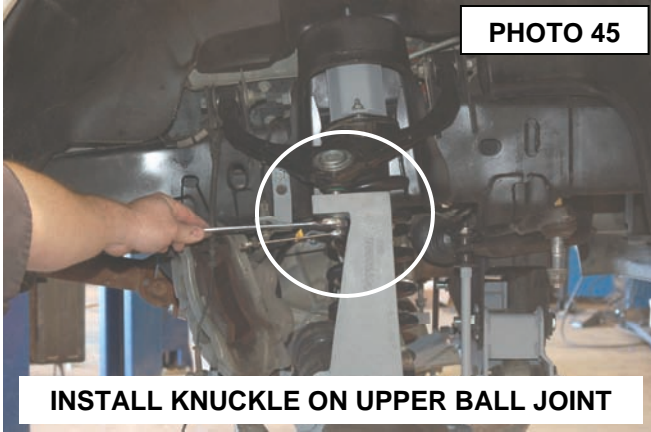

54. Unclip ABS wire from upper control arm and install wire back into bearing assembly using 5mm allen wrench. **See Photo 47.**

55. Using WD-40 move the rubber insulator into right spot and clip back into upper control arm. **See Photo 48.**

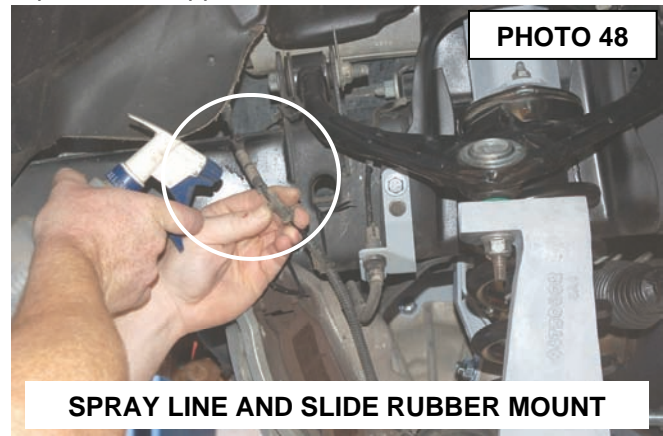
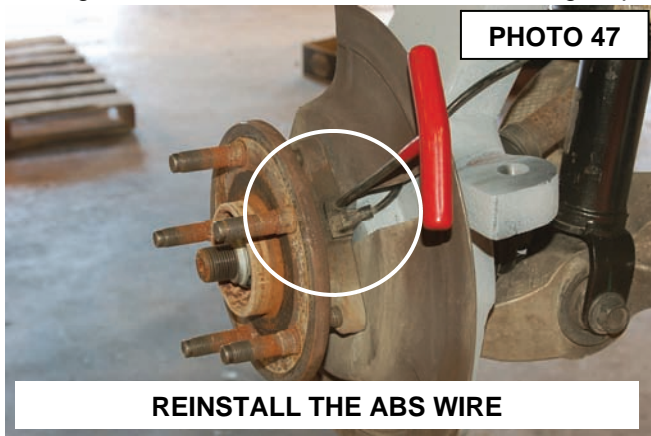

56. Install rotor and brake caliper. Use a 21mm socket to tighten caliper.

57. Install tie rod into knuckle using 21mm wrench. **See Photo 49.**

58. Using a T30 bit remove ABS wire bracket from old knuckle and install on new one. Reinstall the ABS wire on the mount. **See Photo 50.**

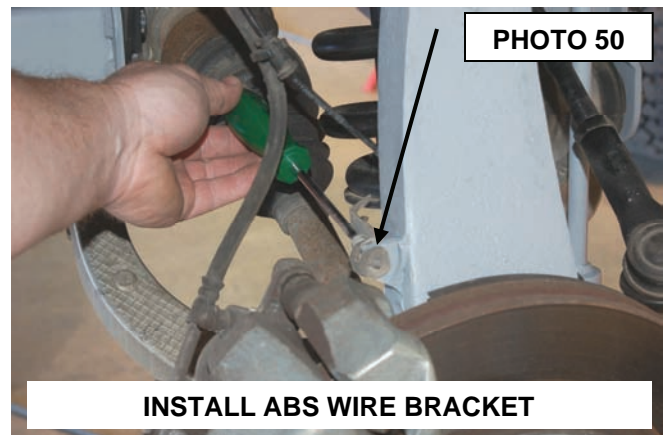
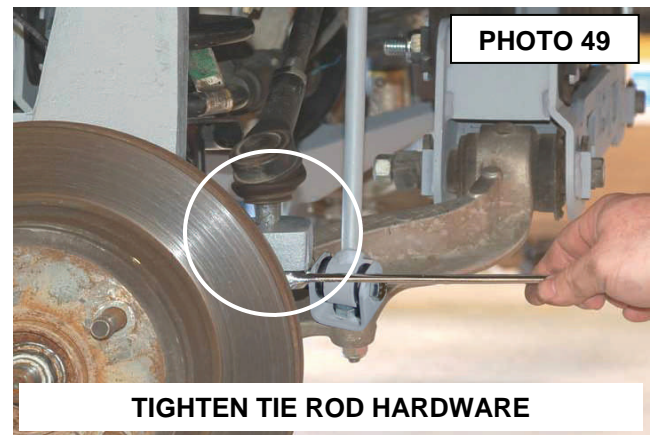

59. Repeat steps 38-57 for opposite side.

60. Install tires and wheels.

61. Remove the jack stands and lower the vehicle to the ground.

62. Tighten lower control arm hardware using a 24mm socket / wrench



REAR INSTALLATION INSTRUCTIONS

1. Remove wheels using a 22mm socket.
2. Remove ABS clip from axle. **See Photo 1.**
3. Remove the brake line as shown in **Photo 2** using 13mm.

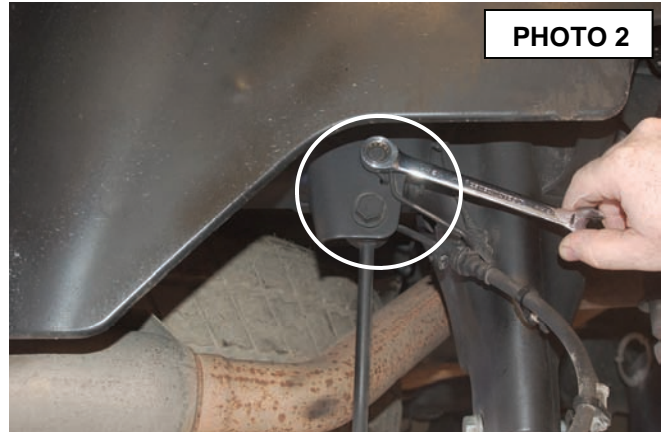
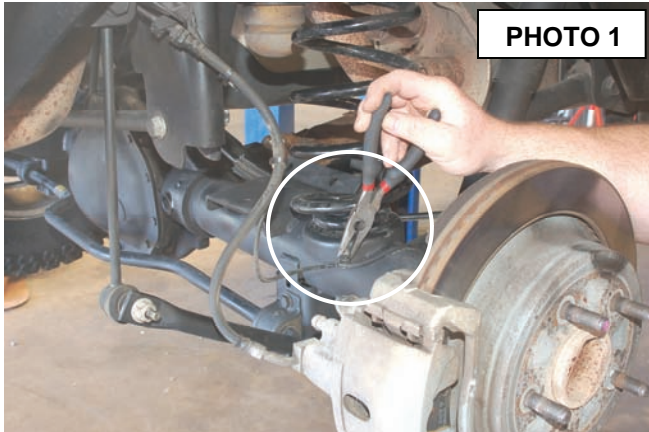

4. Remove sway-bar link using 8mm and 18mm wrench for lower end and 18mm for top end. **See Photo 3 & 4.**

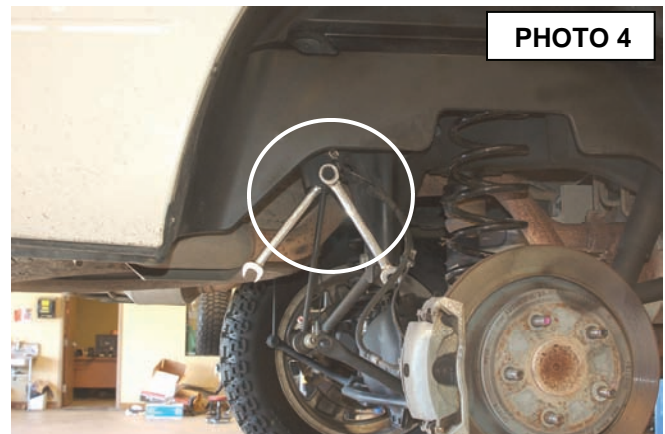

5. Support rear end.
6. Remove the shocks from the axle using 21mm wrench. **See Photo 5.**
7. To remove the upper shocks from the frame mount, remove the inner fender well using 8mm socket. **See Photo 6.** There are **10** bolts on driver side and **10** on passenger side. This is done to gain access to nut on back of shock. Use a socket on back side to remove bolt.

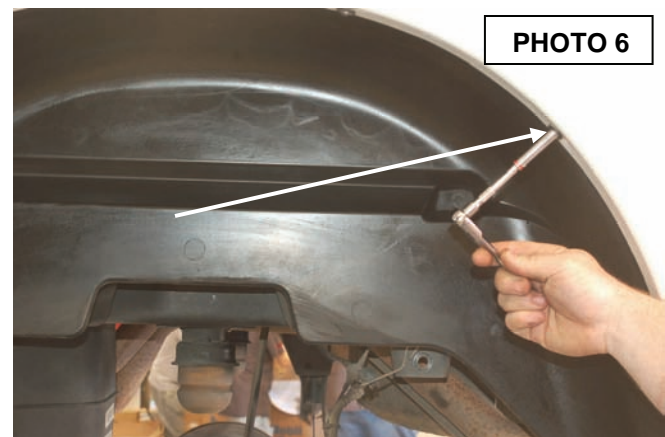

8. Remove upper track bar bolt using 21mm wrench. **See Photo 7.**
9. Remove the vent hose from axle.
10. Remove coil springs. **See Photo 8.**

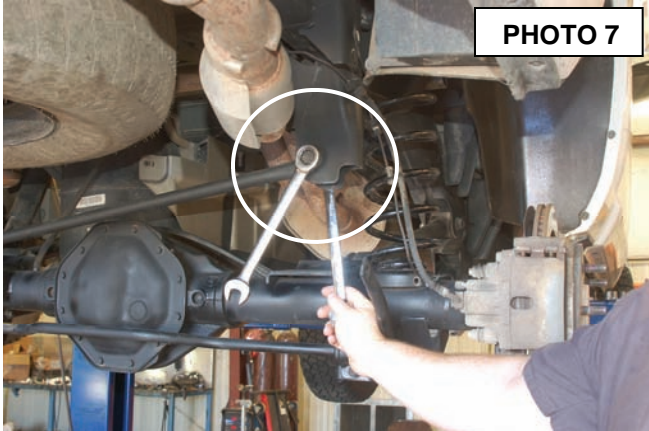

11. Install the flat upper spacer retainer as shown in **Photo 9** on the upper coil seat.
12. Install the spring spacer and secure with the supplied 3/8" x 2 1/2" bolt through the upper flat retainer to hold the spacer in place. Tighten using a 14mm Socket & wrench. **See Photo 10.**

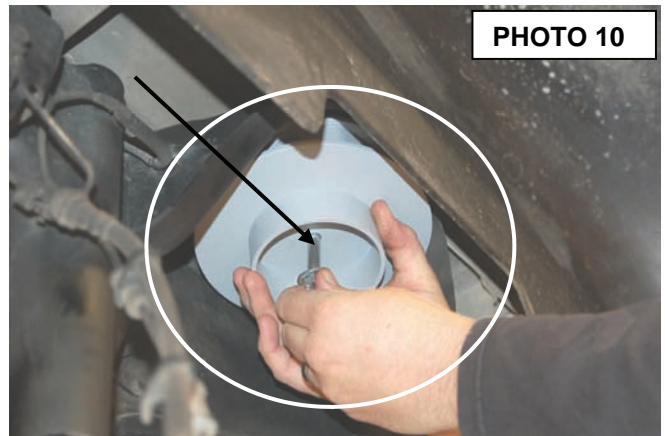
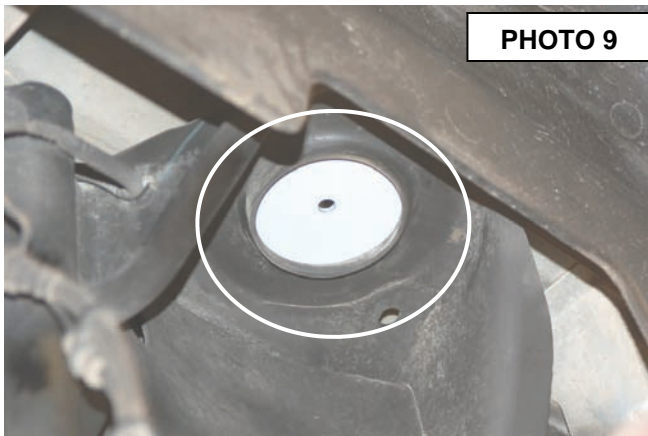

13. Install bump stops using supplied 3/8" x 1" bolts, washers and nuts. The dow pin in the block goes in front hole as shown in **Photo 11**. Tighten hardware using a 14 mm wrench.
14. Install coil spring with stock isolator. **See Photo 12.**

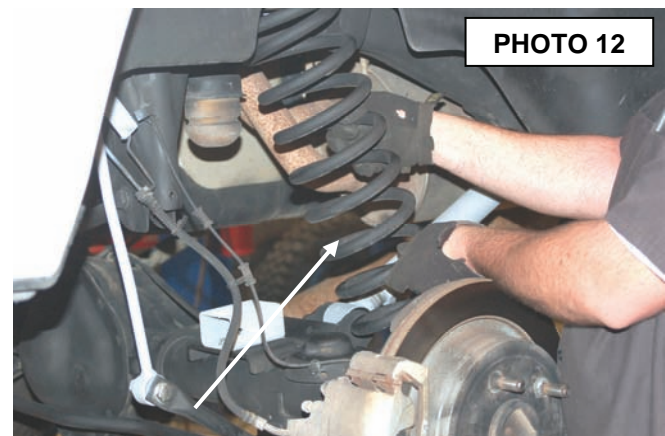
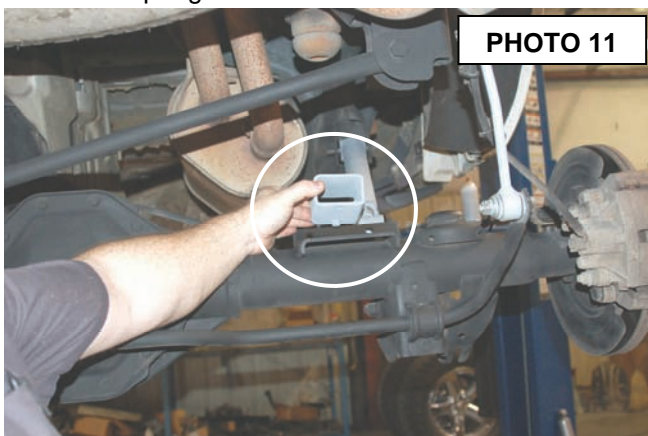

15. Install bushing a sleeves into shocks. Install shock onto truck using stock hardware with new flag nut for top bolt. **See Photo 18. 2.2 Shock Absorbers will install with the body up.**
16. Also install washer on bottom of shock to the outside of truck. **See Photo 19.** Use 21mm to tighten.

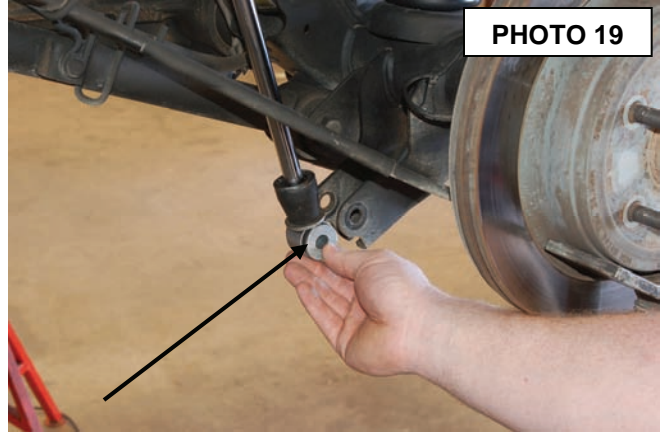
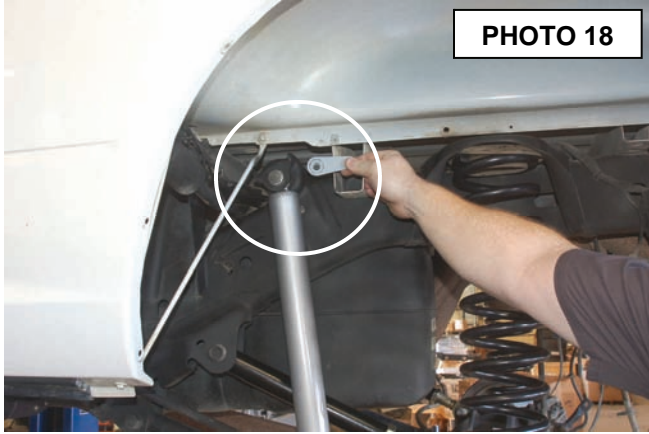

17. Pull down and straighten brake line. Take care not to kink the brake line.
18. Install sway bar links & brake line brackets on the frame with the supplied 12mm x 65mm bolts, washers and nut. **See Photo 20.**
19. Install the stock brake line on the bracket with supplied 5/16" x 3/4" bolt, washers and nut. **See Photo 21.**
20. Use a 18mm and 19 mm to tighten sway bar link bolts and 13 mm for brake line bolts.

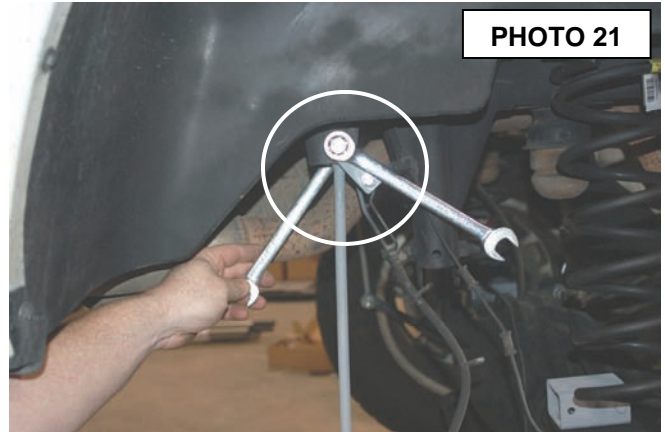
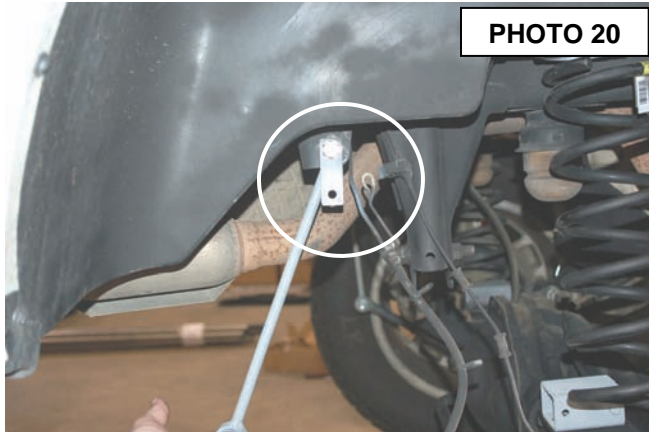

21. Install track bar into bracket with stock bolt. You may have to do this with truck on the ground. Tighten upper bolt using 22mm wrench and lower with 21mm wrench.
22. With WD-40 or alcohol adjust the rubber insulator on ABS wire so that it will fit back into clip on brake line. **See Photo 22.**
23. Cut zip tie for axle vent tube and install new zip tie and vent tube on lower part of frame. **See Photo 23 & 24.**
24. Reinstall fender wells using 8mm socket.
25. Check to make sure all fasteners are tight.
26. Reinstall the track rod in the stock location on the frame. Tighten using a 21mm socket / wrench.

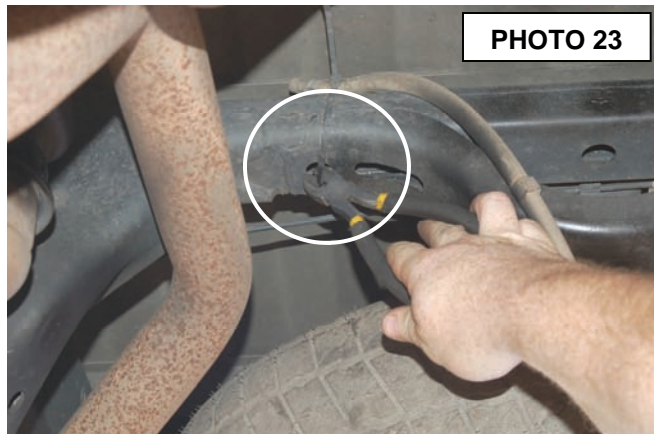
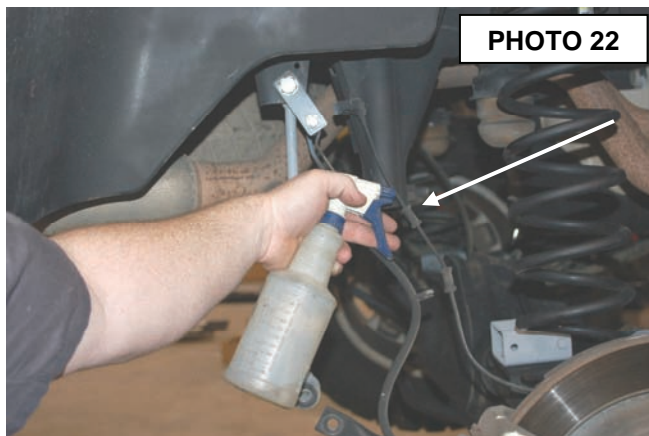

POST INSTALLATION

1. Check all fasteners for proper torque. Check to ensure there is adequate clearance between all rotating, mobile, fixed and heated members. Check steering for interference and proper working order. Test brake system.
2. Perform steering sweep. The distance between the tire sidewall and the brake hose must be checked closely. Cycle the steering from full turn to full turn to check for clearance.
3. Re torque all fasteners after 500 miles. Visually inspect components and re torque fasteners during routine vehicle service.
4. Readjust headlights to proper settings and take truck in for a front-end alignment to a qualified alignment professional.

Thank You for choosing Rough Country for your off road needs!!!

By purchasing any item sold by Rough Country, LLC, the buyer expressly warrants that he/she is in compliance with all applicable , State, and Local laws and regulations regarding the purchase, ownership, and use of the item. It shall be the buyers responsibility to comply with all Federal, State and Local laws governing the sales of any items listed, illustrated or sold. The buyer expressly agrees to indemnify and hold harmless Rough Country, LLC for all claims resulting directly or indirectly from the purchase, ownership, or use of the items.



CUTTING TEMPLATE

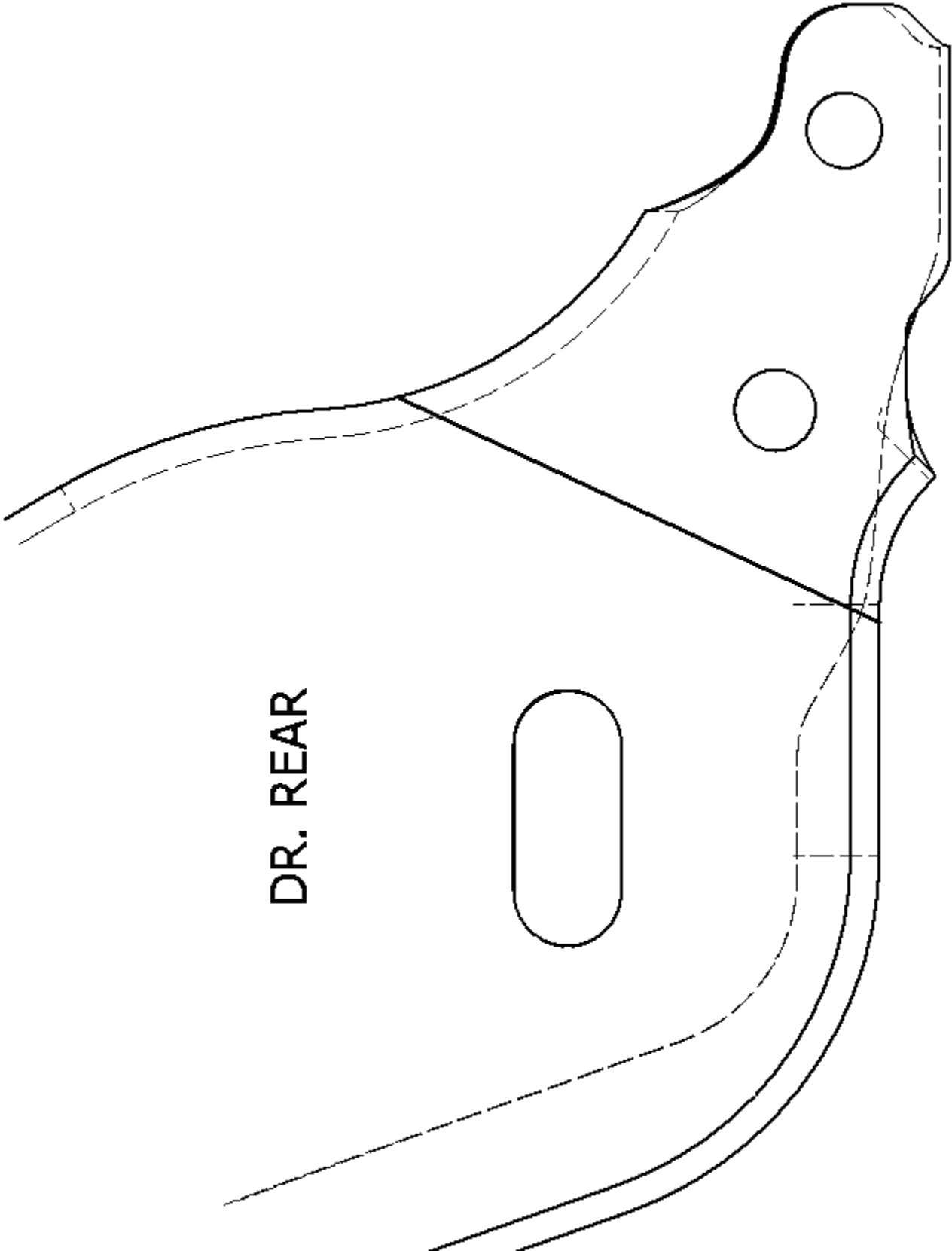

DR. REAR

CUTTING TEMPLATE

