

# QUICK START INSTALL GUIDE *D-Ring Hinge Version*

For Customer Service or Warranty Issues, Contact UnderCover Directly (866) 900-8800 www.undercoverinfo.com

## 1 Install Parts Check List

- A: 2 Hydraulic Struts
- B: 8 Aluminum Clamps, Stainless Steel Bolts, Washers, & Lock Washers
- C: 2 Front Mounting Brackets
- D: 2 Rear Mounting Brackets
- E: 2 J-Hooks and Wall Mounting Screws

**Tools Needed** - 3/8" and 1/2" Wrench or Socket

Mylar Tabs Included

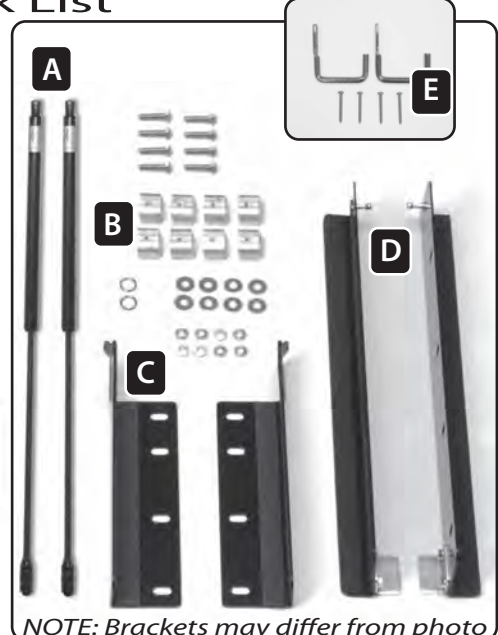
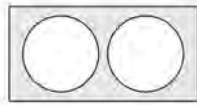

NOTE: Brackets may differ from photo

**NOTE:** UnderCover Tonneaus are designed from trucks that do not have a bedliner (spray-in bedliners pose no problem). Trucks that have plastic drop in bedliners will require some minor trimming of the bedliner to ensure proper placement of the mounting brackets. Any modifications must be made to the bedliner and NOT the UnderCover mounting hardware. Modifications to the mounting hardware could result in improper installation and will void your warranty.

## 2 Rear Mounting Bracket

Install the rear bracket to the truck bed rail near the tailgate. Refer to the Model Specific Guide for measurements and special notes.

Use 2 clamps per bracket, install one clamp in hole 1 and one clamp in the hole nearest the tailgate that is unobstructed by the truck bed.

**!** Do not over tighten and distort the brackets.

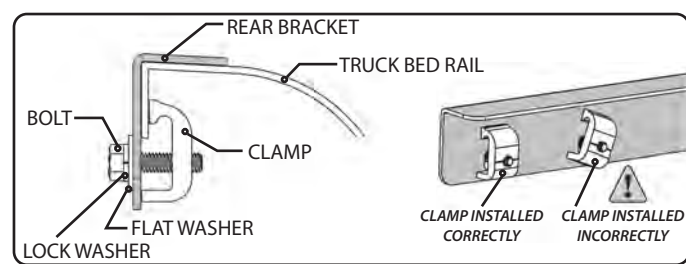
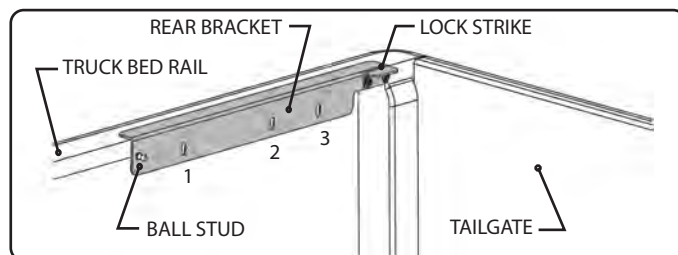
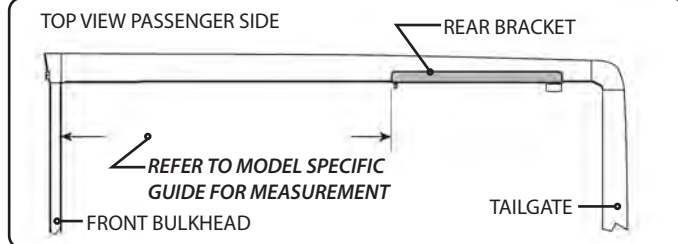

**⚠️ Refer to Model Specific Guide for Special Notes Regarding Your Model**

(866) 900-8800 [www.undercoverinfo.com](http://www.undercoverinfo.com)

## 3 Front Mounting Bracket

Install the front bracket to the truck bed rail near the bulkhead. Refer to the Model Specific Guide for measurements and special notes.

Use 2 clamps per bracket, install one clamp in hole 1 or 2 and one clamp in hole 4. If hole 4 is obstructed by the truck bed, use hole 3.

**⚠️ Do not over tighten and distort the brackets.**

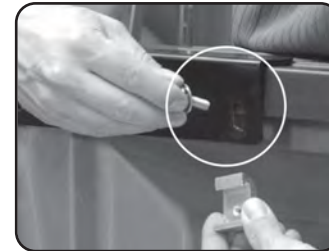
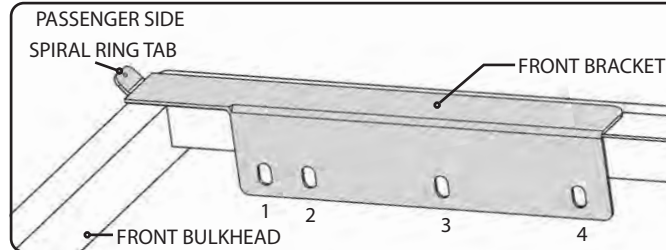
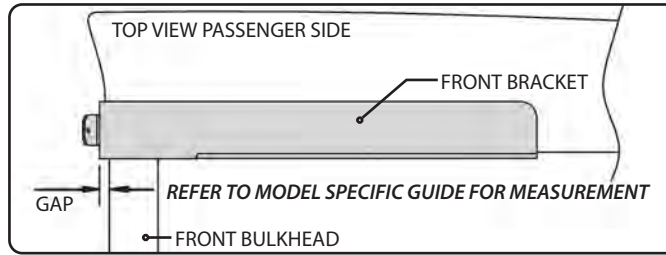

## 4 Install Cover

With some assistance set the bed cover on the truck bed. Position the female hinge over the spiral ring tabs. Install the spiral rings into the holes in the spiral ring tabs.

*NOTE: The rings are simply a safety measure to prevent the cover from slipping off of the tabs in the open position. Once the hydraulic struts are attached and the cover is closed and locked, it is not possible to lift the front of the cover off of the spiral ring tabs.*

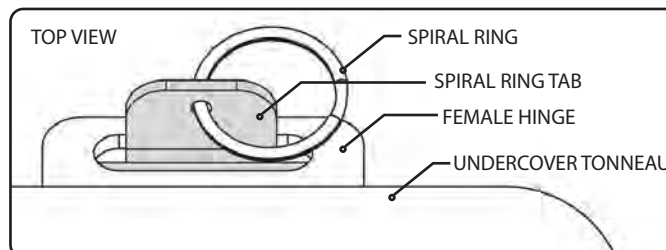
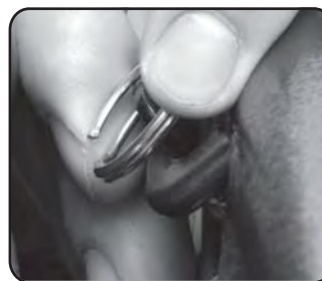
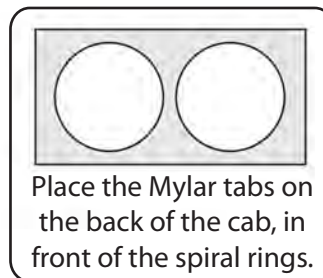

For Customer Service or Warranty Issues, Contact UnderCover Directly

(866) 900-8800 www.undercoverinfo.com

## 4.1 Install Cover (continued)

Be sure the front flap hangs over the bulkhead of the truck.

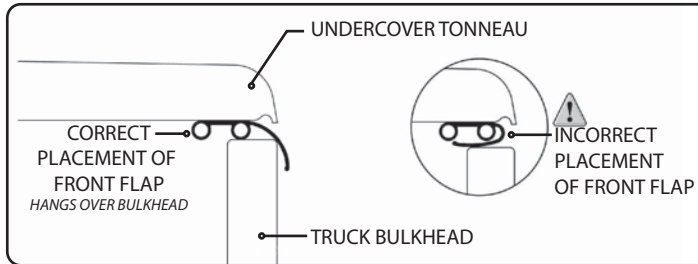

Install the hydraulic struts, attach the large end to the cover and the rod end to the rear mounting bracket (these will snap into place, no tools needed).

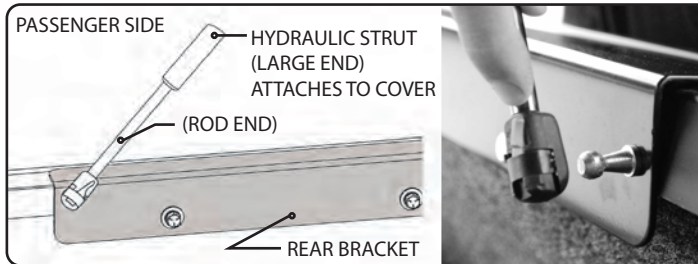

With your cover closed, take a quick inspection to make sure that it is not touching the bed on either side or the tailgate. The desirable gap is no less than 1/8" and no more than 1/4".

To adjust the cover front to back evenly, move both of the front brackets forward or rearward accordingly. To adjust to one side or the other, move the front brackets forward or rearward independently.

## 5 Final Adjustment

Adjust the lock strikes up or down accordingly. With the tailgate down adjust the lock strike to have approximately 1/8" gap between the lock and the lock strike.

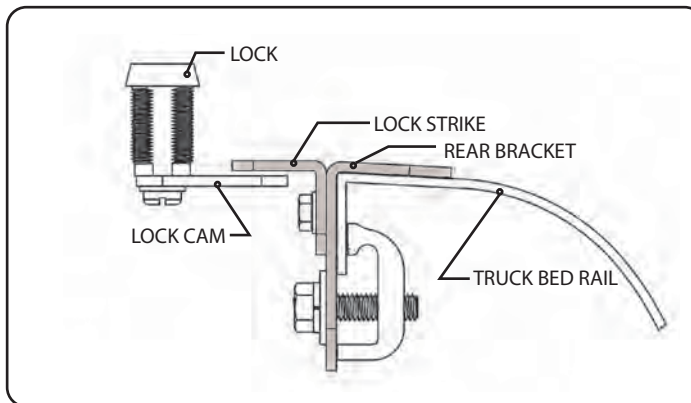

With the tailgate up you should be able to turn the lock with out any resistance. Further adjustment may be needed to achieve this.

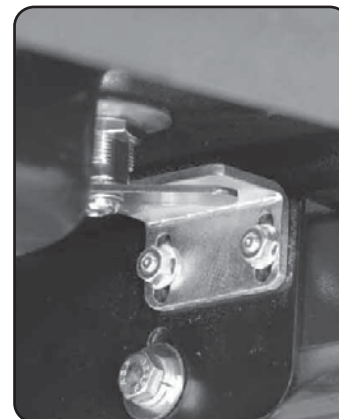

For Customer Service or Warranty Issues, Contact UnderCover Directly

## 1 Minute Removal

### 3 Easy Steps!

**Step 1** - Release strut off of ball stud, be sure to secure cover to prevent it from closing unexpectedly. Place loose end of strut in storage clip. Repeat for other side.

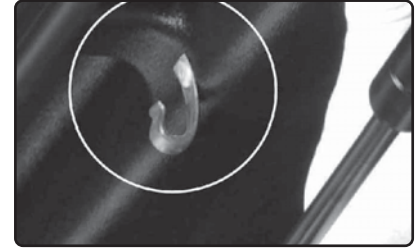

**Step 2** - With the cover closed, remove the spiral rings at the front of the cover.  
*Note: Always be sure to remove the struts prior to removing the spiral rings.*

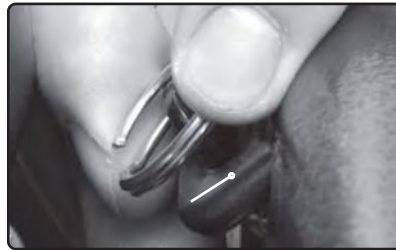

**Step 3** - With some assistance, carefully lift the cover off of the truck bed.

## 1 Minute Re-Install

### 3 Easy Steps!

**Step 1** - Place tonneau cover on the truck bed positioning the female hinges over the spiral ring tabs.

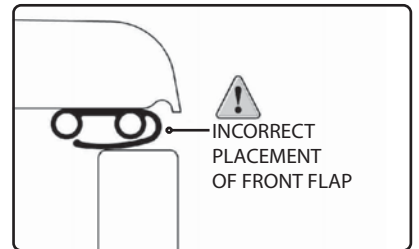

**Step 2** - Install the spiral rings to the spiral ring taps.

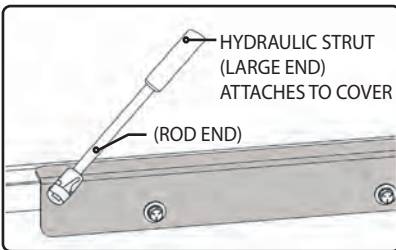

**Step 3** - Open the cover and re-install the struts. Be sure the front flap is hanging over the bulkhead properly.

## Wall Hanging Instructions

**Step 1** - Prior to removing the tonneau, mount the two J-Hooks provided, on the garage wall. The hooks must have a minimum height from the floor of 84". Center horizontally 32" apart from each other.  
*For long bed trucks mount 98" from floor.*

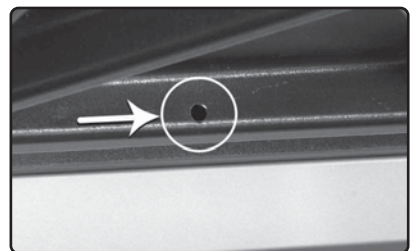
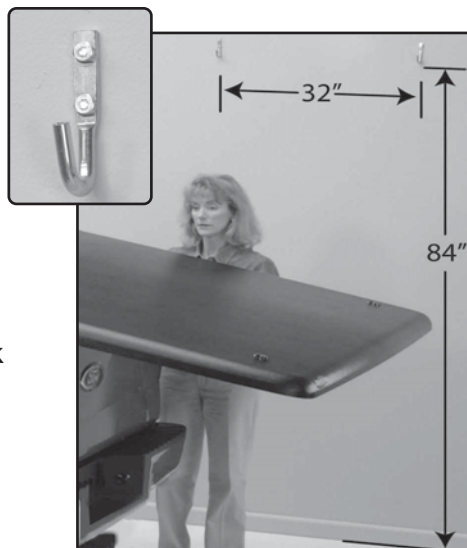

**Step 2** - Remove your tonneau from the truck bed.



**Step 3** - Hang the tonneau vertically on the hooks, under side against the wall, inserting the hooks into the holes provided.