



INSTALLATION INSTRUCTIONS HIDDEN WINCH MOUNTING KIT

No. 61770

for Chevrolet & GMC Trucks

(for Warn Winches M6000, M8000, XD9000 & HS9500 only)

Warn Light Bar 61090 and many other grille guards can be mounted in combination with this unit.

PARTS LIST

PART NO.	QUANTITY	DESCRIPTION
61805	1	Mounting Plate
61634	2	Side Bracket
61771	1	Control Pack Bracket
61636	2	Brace
61806	4	Nut w/Handle
35138	1	Clutch Lever, Special
14867	1	Remote Control Lead

TORQUE SPECIFICATIONS

1/4	8 lb. ft. (10.8 N-m)
3/8	30 lb. ft. (40.7 N-m)
7/16	50 lb. ft. (67.8 N-m)
M12	58 lb. ft. (78.6 N-m)

As you read these instructions, you will see **NOTES**, **CAUTIONS** and **WARNINGS**. Each message has a specific purpose. **NOTES** are additional information to help you complete a procedure. **CAUTIONS** are safety messages that indicate a potentially hazardous situation which, if not avoided, may result in minor or moderate injury. A **CAUTION** may also be used to alert against unsafe practice. **WARNINGS** are safety messages that indicate a potentially hazardous situation, which, if not avoided could result in serious injury. **CAUTIONS** and **WARNINGS** identify the hazard, indicate how to avoid the hazard, and advise of the probable consequence of not avoiding the hazard. **PLEASE WORK SAFELY!**

NOTE: This installation requires hole drilling. Make sure you have a drill motor and a sharp 7/16" drill available. Wear safety goggles.

(A) Remove the grille and bumper. The grille must be removed first to gain access to the bumper bolts. These are easy to remove if the following procedure is followed:

- a. Open the hood. Remove the four plastic fasteners, which attach the plastic shroud to the top of the grille. Pry up the center pin with a screwdriver, then pry out the fastener.
- b. Remove the bolt just to right of latch (10mm head).
- c. Locate the four phillips head plastic fasteners just inboard of the lights. Gently turn ¼ turn counterclockwise while pulling out on the grille to release. Give a sharp pull at extreme outer ends of grille to release snaps. Remove grille.
- d. Remove the bulb sockets from the backside of the fog lights, if so equipped.
- e. Remove the bolts from the outer bumper braces just forward of the wheels (15mm head).
- f. Remove the four remaining bumper bolts (18mm head) and remove bumper.

(B) Remove the plastic splash pan/air deflector that attaches to the two vehicle crossmembers. This will not be used, since the Winch Mounting Plate will serve the same purpose.

1. Temporarily install the Winch Mounting Plate and Side Brackets as shown in **Photo 1**. Be sure to use the thick spacer washers between the Brackets and the vehicle frame. Use the supplied M12x40mm bolt in place of the factory bolt at the front hole location. **The thick washers should not be used at the front holes when mounting the Warn Light Bar #61090 or other grille guards that share this hole. In these cases, the mounting tab of the bar or guard becomes the spacer. Some guards may have tabs that require deleting the thick washers at the Side Brackets also.**

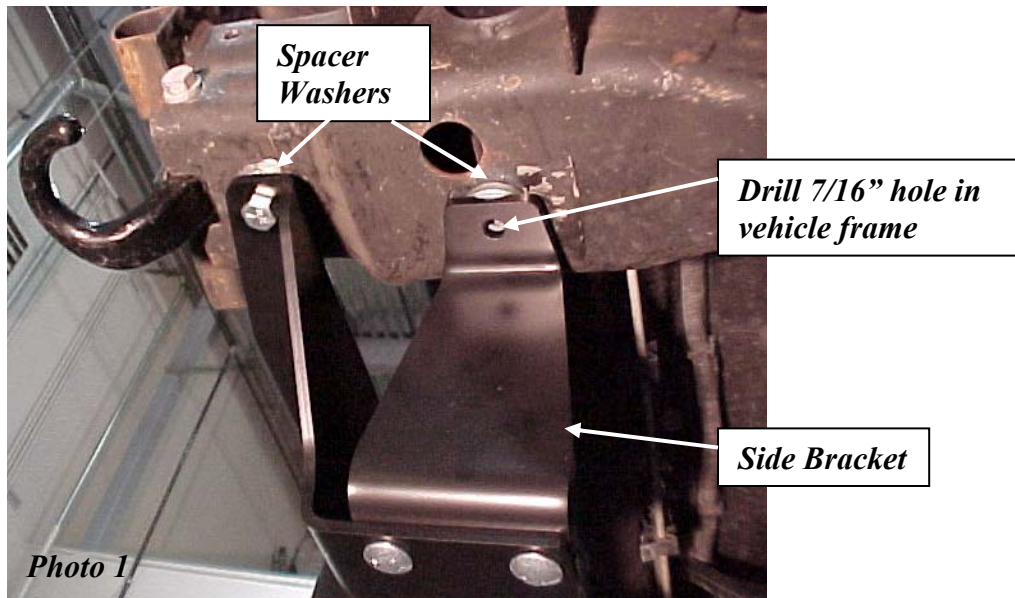

2. Using hole in the Side Brackets as a guide, mark the vehicle frame for drilling. Remove the brackets and drill a 7/16" hole at each marked location.



WARNING



Drilling operations can cause flying metal chips. **WEAR SAFETY GOGGLES.** Flying metal chips can cause eye injury.

3. Minor modifications to the winch are required to make it compatible with this mount. First, replace the clutch handle with the special one supplied. Second, the clutch housing must be rotated two bolt holes clockwise as

shown in **Photo 2**. This is easy to do by removing the ten allen head screws, pulling the housing out about 1/8” and then rotating exactly two bolt holes. Reinstall and tighten the screws.

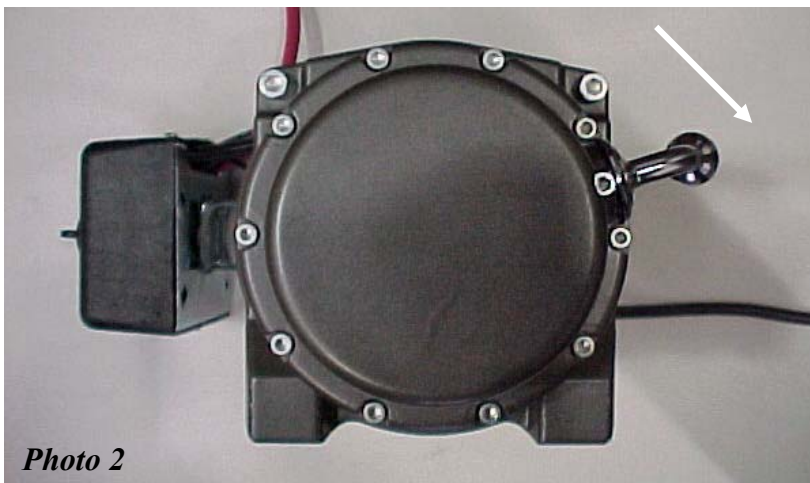

Rotate clutch housing clockwise

- 4. Prior to installing the winch on the Mounting Plate, refer to **Photos 3 & 4** attach the ground wire to the motor. Also install the Control Pack Bracket to the Mounting Plate. Now install the winch, control pack and roller fairlead using the instructions and fasteners packaged with the winch.

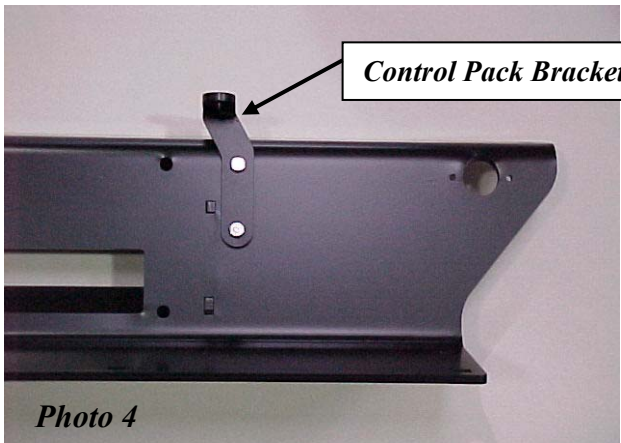
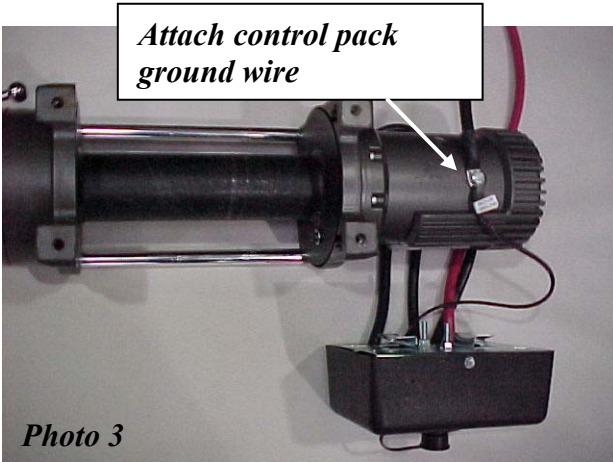

- 5. Install the complete assembly up to the vehicle frame. A floor jack is suggested. See **Photos 5 & 6**. Once again, use the spacer washers if not installing a light bar or other guard. Use the “nuts with handle” inserted thru access holes in the frame. Leave fasteners slightly loose. Install Braces as shown. Now tighten all fasteners securely.

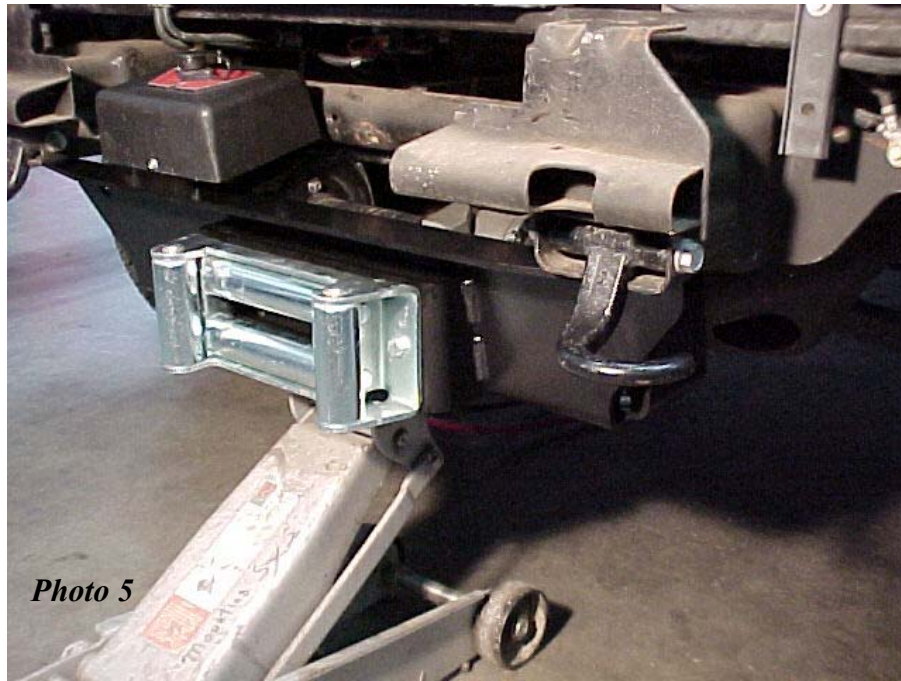

Photo 5

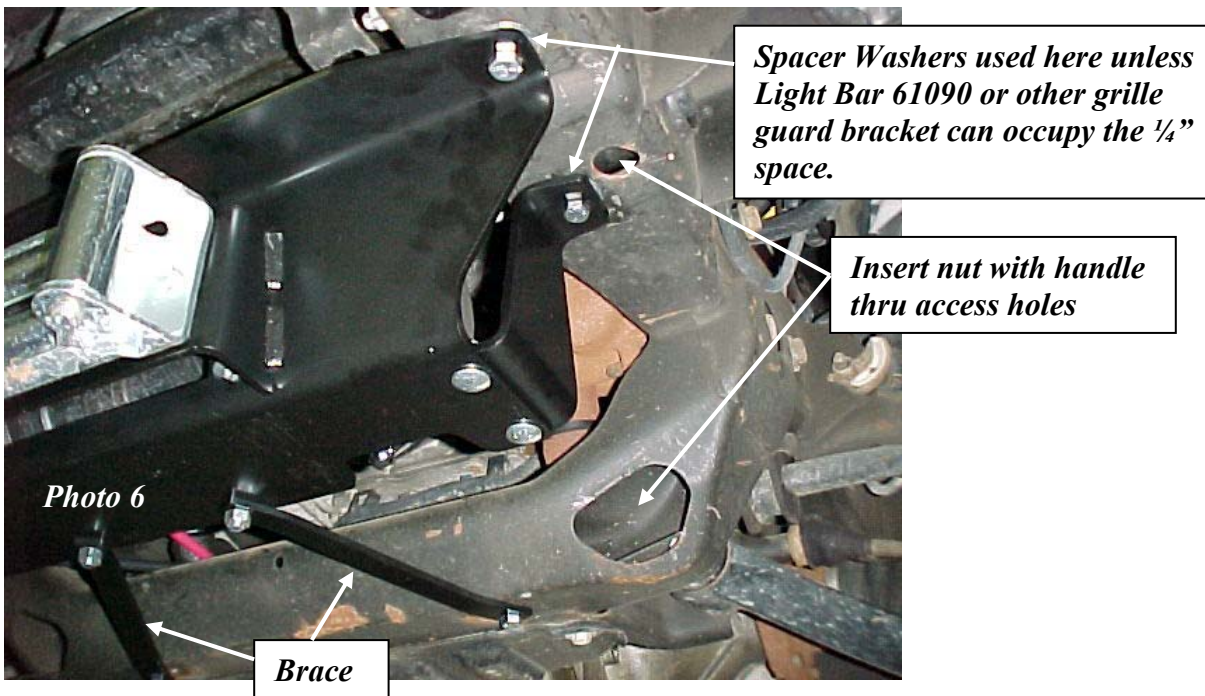
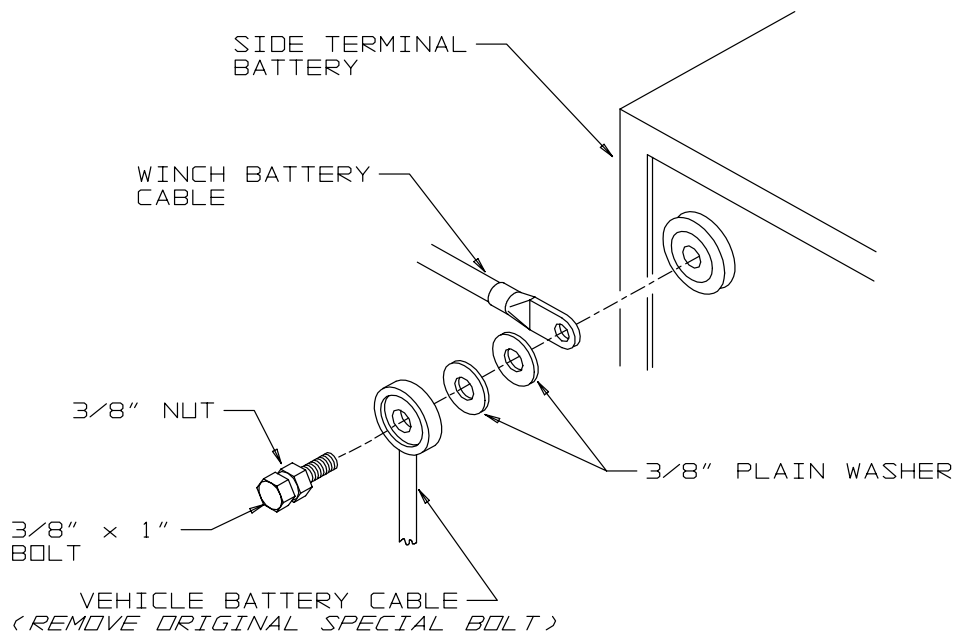
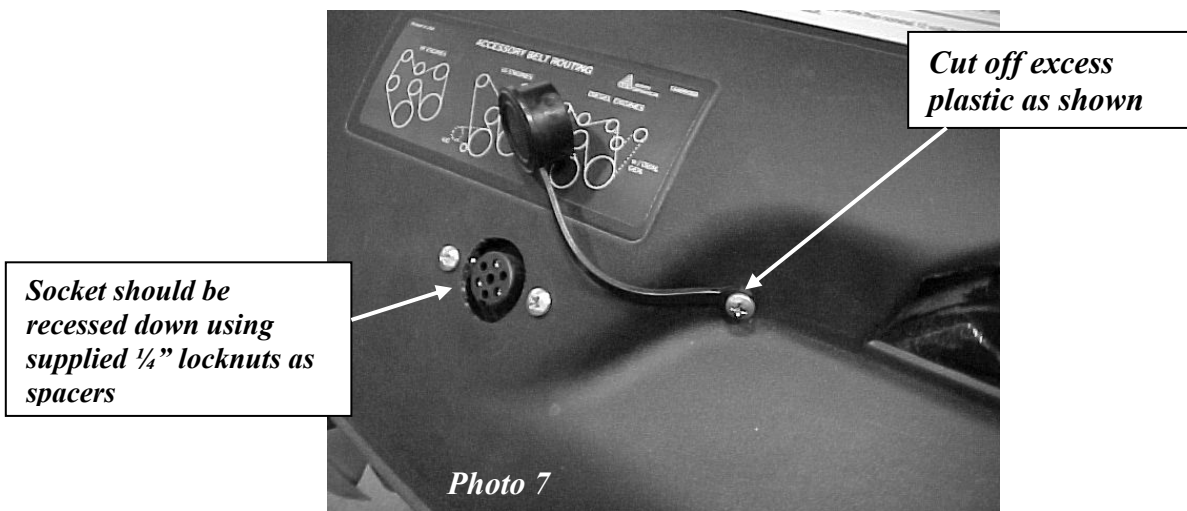

Photo 6

6. Route the battery cables up to the battery as follows: The red (+) cable should exit the control box and be routed to the rear between the winch motor and the tubular crossmember. Bring the black (-) cable up to meet the red and tie wrap them to the vehicle wiring harness just under the radiator shroud. Route them towards the left and over the top of the left frame rail, then up towards the battery. Make the connections to the side terminal battery using the supplied hardware shown in the following diagram. Use the tie wraps to secure the cables away from sharp edges and moving parts.



7. The Remote Control Socket can be installed in a variety of locations depending on usage and preferences. These photos show three suggested locations, but others can also be used. **Photo 7** shows a very clean location for the socket under the hood, just towards the passenger side from the hood latch. This location requires the hood to be up on the safety catch when the remote control is plugged in, but it is up away from road spray and out of sight. For best clearance to bottom side of hood, use exact location shown. Mount the socket from underneath and recess it down using the supplied $\frac{1}{4}$ " locknuts as spacers. To mount the dust cap as shown, the excess plastic can be trimmed away as shown leaving just an eyelet for the screw.



8. **Photo 8** shows a position down by the right hand tow hook. Holes are provided in the Winch Mounting Plate. This position also has a clean appearance, but is a bit more difficult to use.

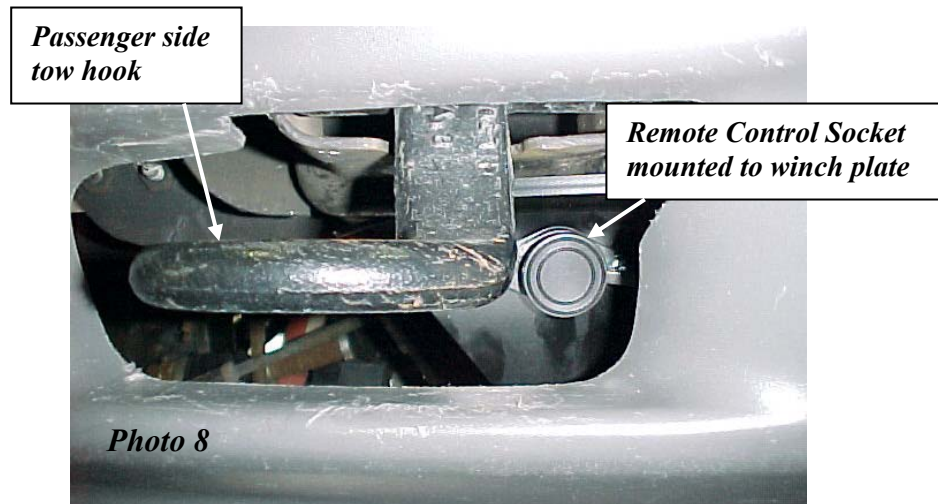

9. **Photo 9** shows the socket mounted on the outside of the lower plastic area of the bumper. This location is the easiest to use and may be a good choice if the winch will be used often.

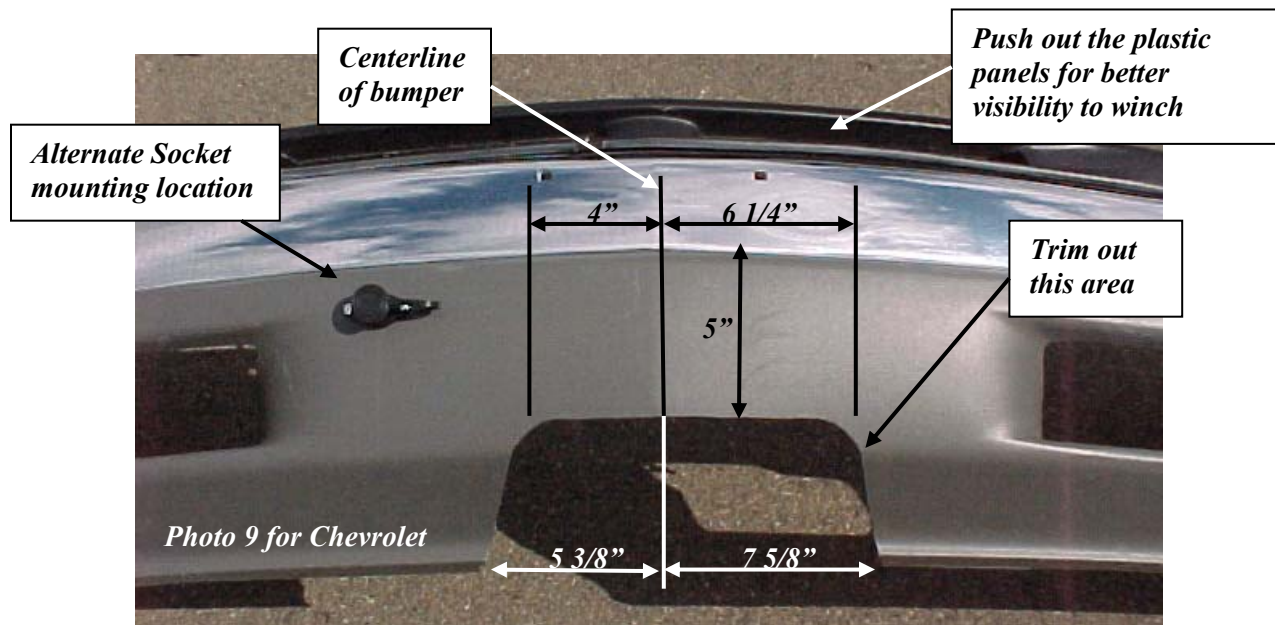

10. Before the bumper can be reinstalled, the lower plastic area requires trimming out to provide clearance for the roller fairlead. Refer to **Photo 9** for Chevrolet trucks and to **Photo 10** for GMC. The plastic can be easily cut with a small keyhole saw, Dremel type rotary cutter or a sharp knife. It is always a good idea to cut a little smaller opening than shown, then carefully enlarge it a little at a time to achieve a close fit. When trial fitting the bumper, be sure to start to thread in the four central mounting bolts and center the bumper side to side. A sharp Exacto knife works well to trim and even up the edges.

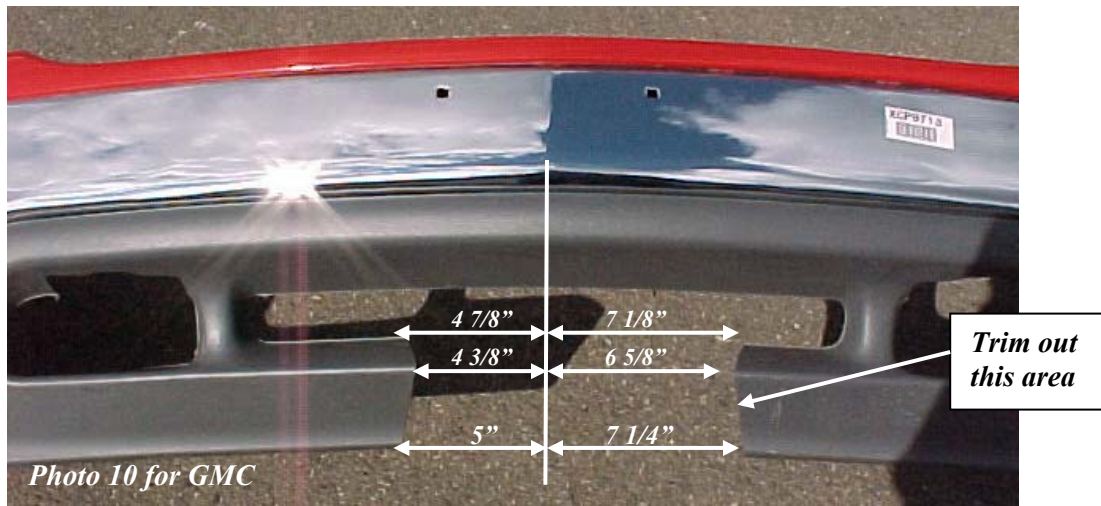

11. The finished installation is shown in **Photos 11 & 12** for Chevrolet and **Photos 13 & 14** for GMC. The Roller Fairlead Cover shown is highly recommended for a clean appearance and to help support the trimmed-out plastic, especially on the GMC. Order cover **35363 for Chev** or **25580 for GMC**.



12. Install the bumper and tighten securely. Be sure to reattach fog light sockets. Reinstall grille.