



INSTALLATION INSTRUCTIONS ROCK SLIDERS

Part Number: 74580

Application: 2007 JEEP JK WRANGLER 2 DOOR

Your safety, and the safety of others, is very important. To help you make informed decisions about safety, we have provided installation and operating instructions and other information on labels and in this guide. This information alerts you to potential hazards that could hurt you or others. It is not possible to warn you about all potential hazards associated with this product, you must use your own good judgment.

**CARELESS INSTALLATION AND OPERATION CAN RESULT IN SERIOUS INJURY OR EQUIPMENT DAMAGE.
READ AND UNDERSTAND ALL SAFETY PRECAUTIONS AND OPERATING INSTRUCTIONS BEFORE
INSTALLING AND OPERATING THIS PRODUCT.**

This guide identifies potential hazards and has important safety messages that help you and others avoid personal injury or death. **WARNING** and **CAUTION** are signal words that identify the level of hazard. These signal words mean:

WARNING signals a hazard that could cause serious injury or death, if you do not follow recommendations.

CAUTION signals a hazard that may cause minor to moderate injury, if you do not follow recommendations.

This guide uses **NOTICE** to call attention to important mechanical information, and **Note**: to emphasize general information worthy of special attention.

WARNING

INJURY HAZARD

Failure to observe these instructions could lead to severe injury or death.

- Always** use extreme caution when drilling on any vehicle. Make sure that all fuel lines, brake lines, electrical wires, and other objects are not punctured or damaged when/if drilling on the vehicle. Thoroughly inspect the area to be drilled (on both sides of material) prior to drilling, and relocate any objects that may be damaged. Failure to inspect the area to be drilled may result in vehicle damage, electrical shock, fire or personal injury.
- Always** wear safety glasses when installing this kit. A drilling operation will cause flying metal chips. Flying chips can cause eye injury.
- Always** use extreme caution when cutting and trimming during fitting.
- Always** remove jewelry and wear eye protection.
- Always** use appropriate and adequate care in lifting components into place.
- Always** insure components will remain secure during installation and operation.
- Always** tighten all nuts and bolts securely, per the installation instructions..
- Always** replace all worn or damaged parts before operating.
- Never** operate this WARN product with damaged or missing parts.

Caution

Moving Parts Entanglement Hazard

Failure to observe these instructions could lead to minor or moderate injury.

- Always** take time to fully read and understand the installation and Operations Guide included with this product.

Read installation and operating instructions thoroughly.

I. TABLE OF CONTENTS

Parts List	page 2
Tools Required	page 2
Torque Specifications	page 2
Installation	page 2-8
Maintenance/Care	page 8

II. PARTS LIST

<u>Part Number</u>	<u>Qty</u>	<u>Description</u>
75733	1	Hardware Kit
75728	1	RH Rock slider
75729	1	LH Rock slider

III. TOOLS REQUIRED

- Standard Socket Set
- 3/8 Racket
- Standard Wrench Set
- Standard Screw Driver
- Drill Motor
- 3/8" and 5/16" Drill bit

IV. TORQUE SPECIFICATIONS

5/16"	18 lb. ft. (24.4 N-m)
3/8"	35 lb. ft. (47.5 N-m)
7/16"	50 lb. ft. (67.8 N-m)

V. INSTALLATION

1. Remove factory components (if so equipped)

Remove the factory side boards, steps, or other rock sliders from vehicle.

Clean side rocker panels under the doors

2. Prepare the sides of the vehicle

Using a 3/8" drill bit and drill motor, carefully drill out the factory mounting holes as shown in **Figure 1**.

WARNING



Drilling operations can cause flying chips. **WEAR SAFETY GOGGLES.**
Flying chips can cause eye injury.

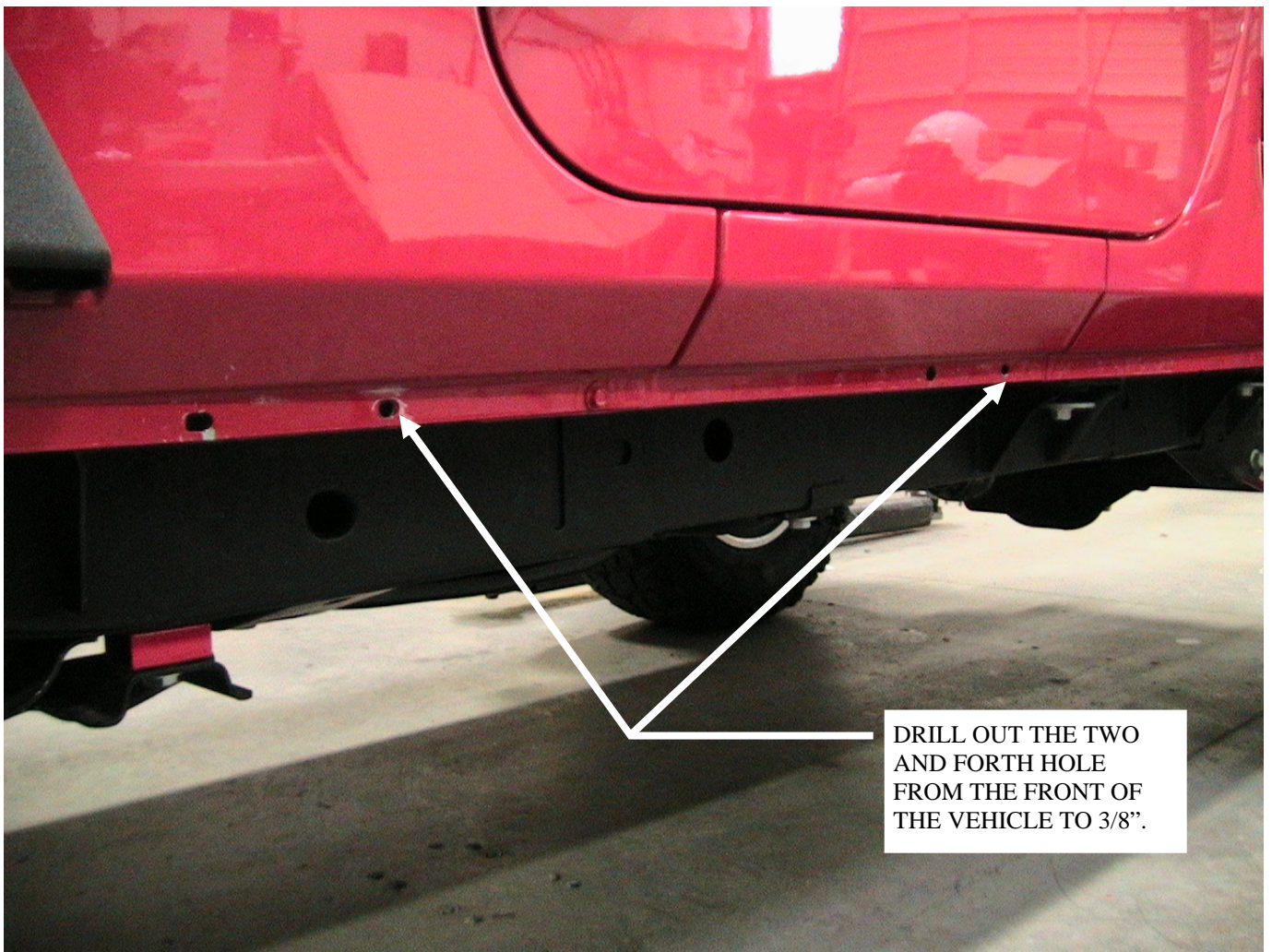

Figure 1: Viewing from the driver's side of vehicle, Drill out the second and fourth factory holes on the body sill. Repeat for the passenger's side.

Once the two factory holes on each side are drilled out to 3/8", temporarily install the appropriate rock slider to the side of the rocker sill using six 3/8" bolts. While holding the rock slider in line with the holes in the rocker sill, mark the sill with a pen, using the 5/16" mounting in the rear most bracket as a guide. Use **Figure 2, 3 and 4** for appropriately identifying the left and right rock slider and rear hole locations for drilling.

Remove the rock slider and drill the two marked holes using a 5/16" drill bit.

⚠ WARNING



Drilling operations can cause flying chips. **WEAR SAFETY GOGGLES.**
Flying chips can cause eye injury.

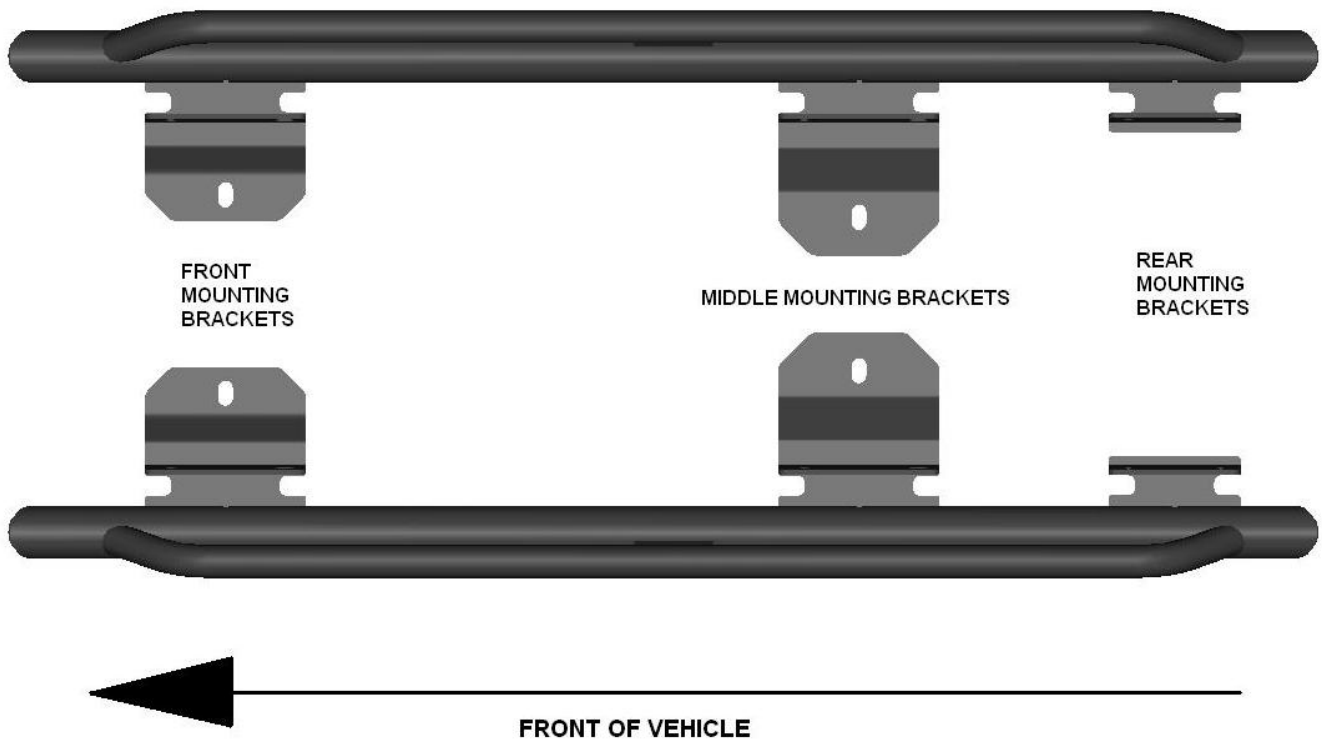

Figure 2: Identifying the Left and Right Rock Sliders

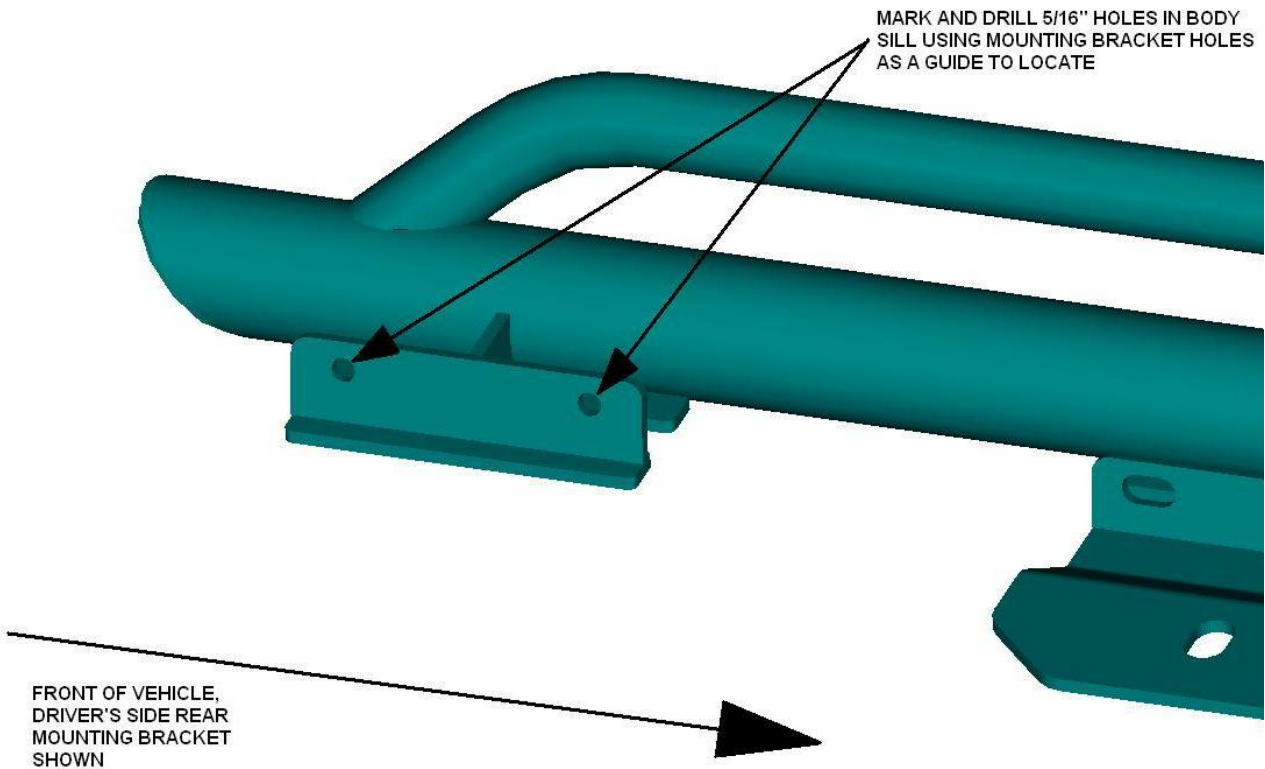

Figure 3: Location of 5/16" holes to be drilled in body sill at rear mounting location

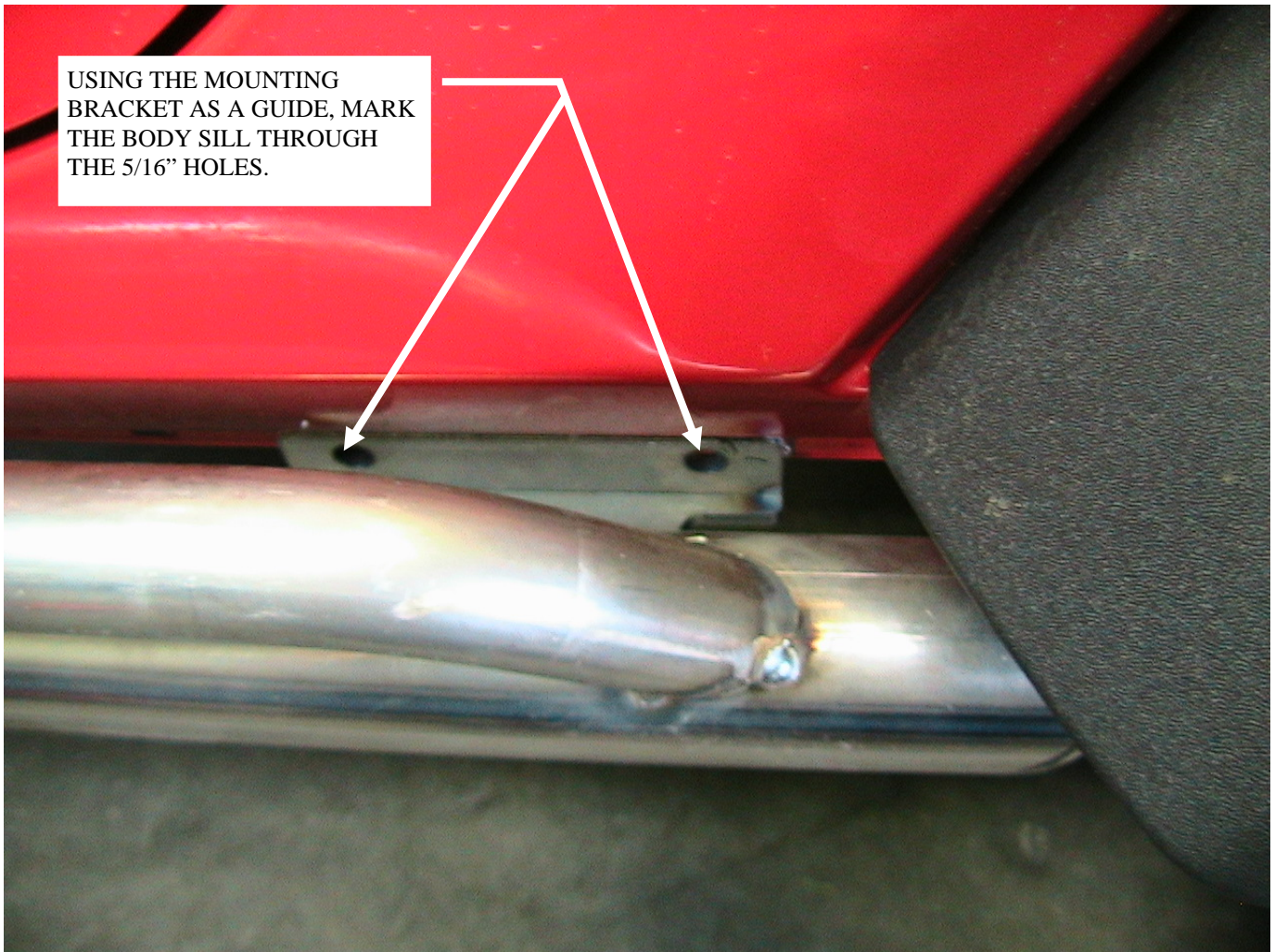

Figure 4: Place rock slider on sill and mark the two 5/16" rear holes on each side of vehicle

Once the 5/16" holes are drilled, proceed to the next section for installation.

3. Install the rock sliders

Place the appropriate rock slider on the side of the vehicle. Install a 3/8" x 1-1/4" long bolt with flat washer through each of the four 3/8" hole locations. Install a 5/16" x 1-1/4" long bolt and flat washer through each of the two 5/16" rear hole locations. Install a 3/8" flat washer, 3/8" lock washer and 3/8" nut onto each of the four 3/8" bolts. Install a 5/16" flat washer, 5/16" lock washer and 5/16" nut onto each of the two 5/16" bolts. Do not tighten the bolts at this time. **See Figure 4.**

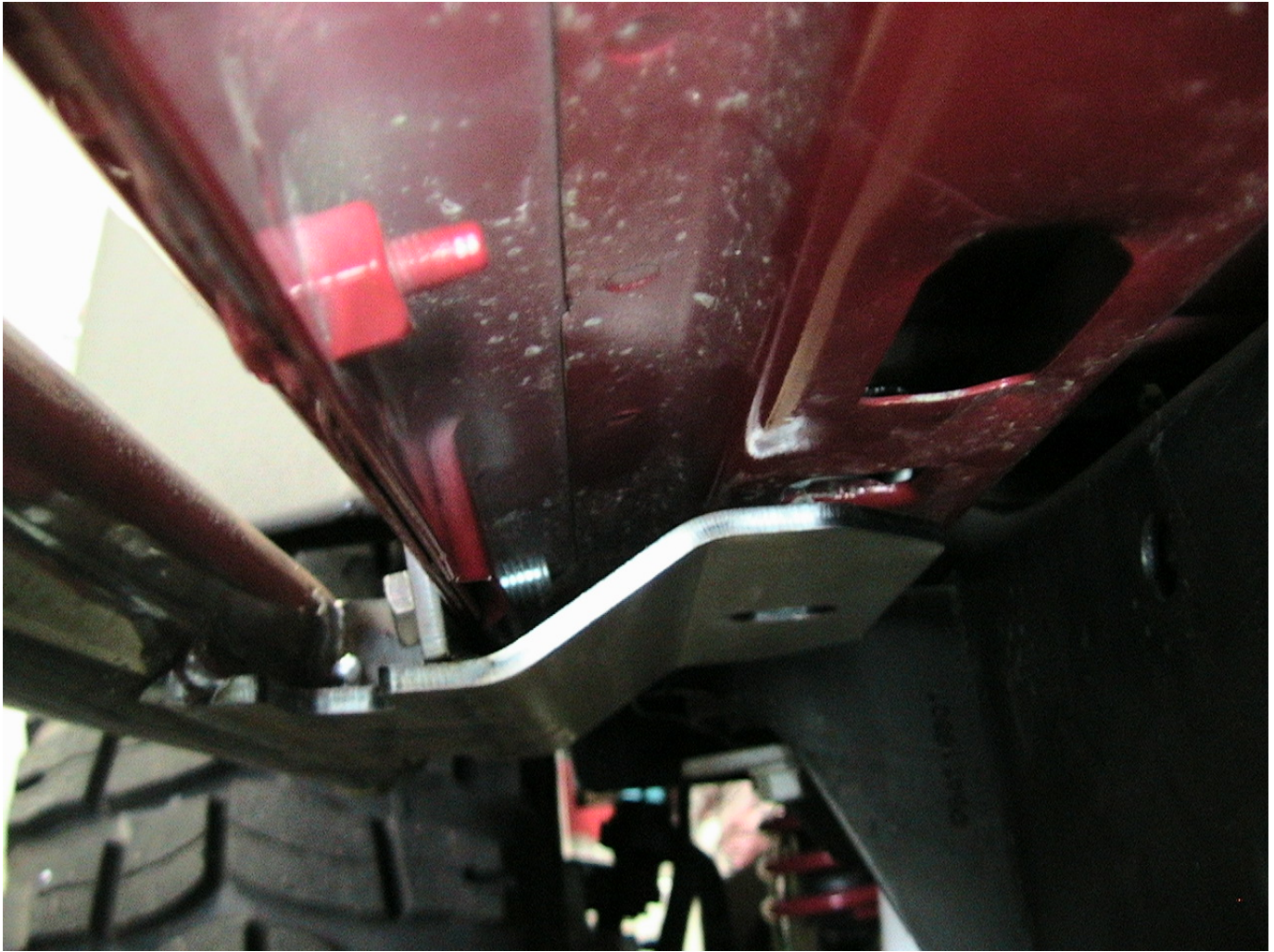

Figure 4: Install four 3/8" bolts and washers through the mounting bracket and then the body sill. Install two 5/16" bolts and washers through the mounting bracket and the two previously drilled holes in rear mounting bracket.

Using **Figure 5 and 6** as a guide, install the nut and rod assembly through the access cutouts and hold the nut over the slotted holes in the floor mounting locations. Install a 7/16" x 1-1/4" long bolt with a 7/16" lock washer and 7/16" flat washer through the mounting bracket, underside of body and into the nut assembly. Repeat this for the front and middle mounting bracket locations.

INSTALL 7/16 NUT ASSEMBLY THROUGH THE ACCESS CUTOUTS IN BODY BEHIND THE FRONT MOUNTING LOCATION. LOOK THROUGH THE MOUNTING BRACKET HOLE TO LOCATE THE NUT AND THEN INSTALL THE 7/16" BOLT, LOCK WASHER AND FLAT WASHER THROUGH MOUNTING BRACKET, BODY AND INTO THE NUT ASSEMBLY.

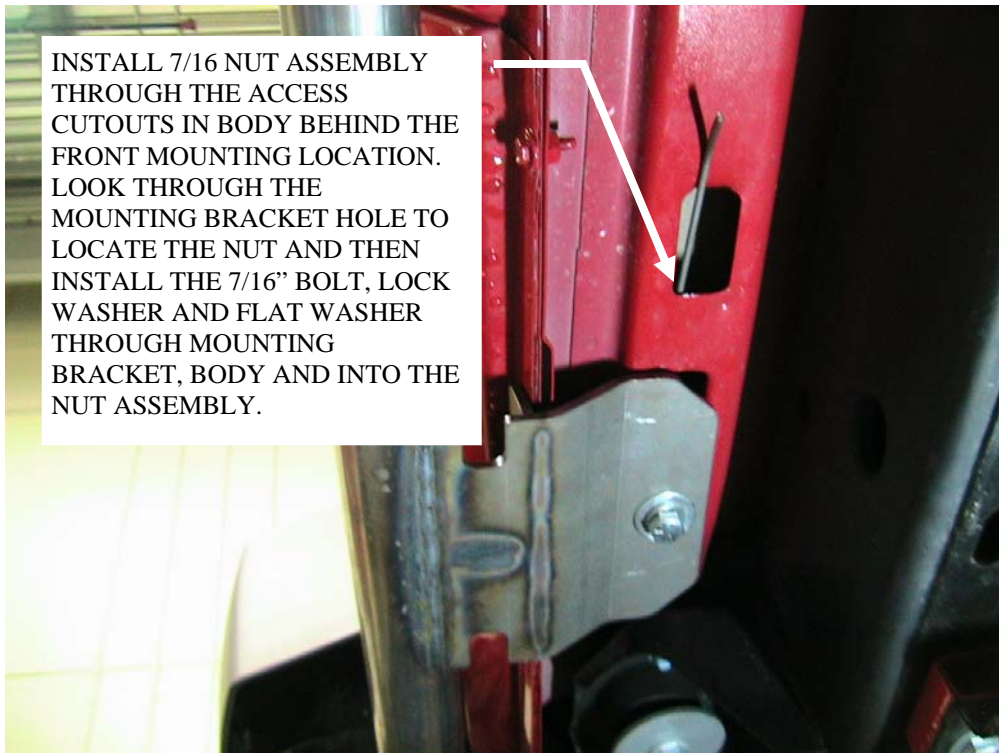

Figure 5: Underside of body front mounting location

INSTALL 7/16 NUT ASSEMBLY THROUGH THE ACCESS CUTOUTS IN BODY FORWARD OF THE MIDDLE MOUNTING LOCATION. LOOK THROUGH THE MOUNTING BRACKET HOLE TO LOCATE THE NUT AND THEN INSTALL THE 7/16" BOLT, LOCK WASHER AND FLAT WASHER THROUGH MOUNTING BRACKET, BODY AND INTO THE NUT ASSEMBLY.

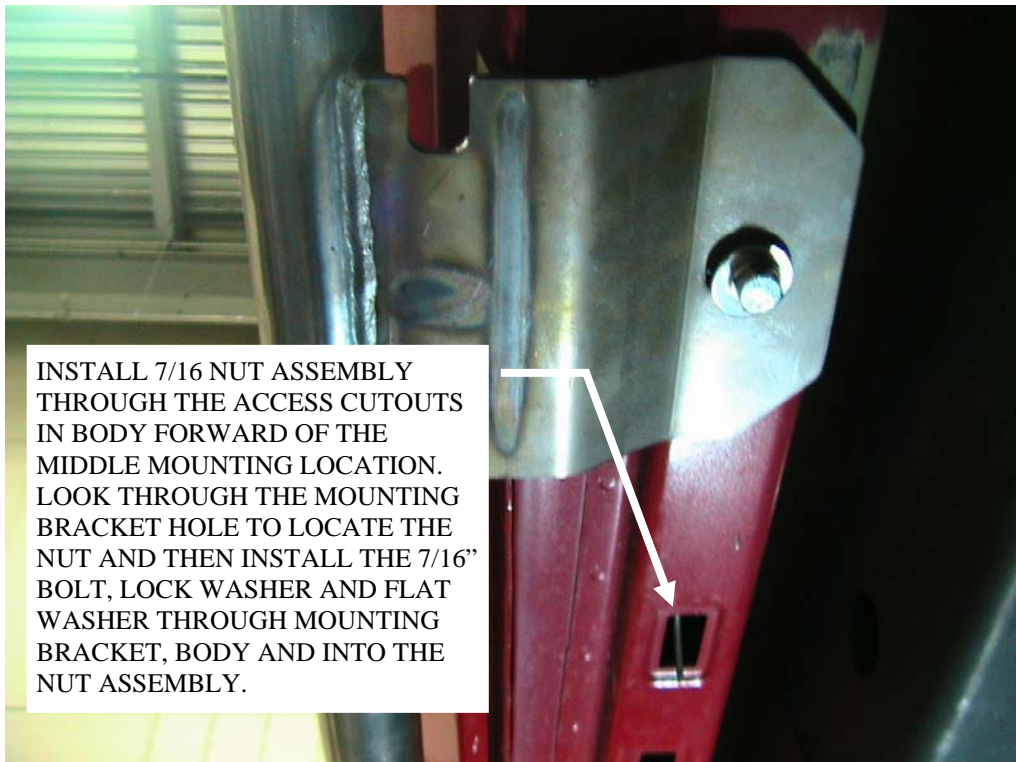

Figure 6: Underside of body middle mounting location

Once all of the mounting bolts are installed, begin tightening all of the mounting bolts to their proper torque specification.

Torque the 3/8" sill bolts first. Then tighten the 5/16" sill bolts.

Torque the underside body mounting bolts last.

Repeat this process for both sides of the vehicle.

THE ROCK SLIDER INSTALLATION IS NOW COMPLETE. PROCEED TO SECTION IV TITLED "MAINTENANCE/CARE".

 **CAUTION**

FAILURE TO SECURELY TIGHTEN ALL BOLTS CAN RESULT IN PRODUCT FAILURE WHICH MAY RESULT IN VEHICLE DAMAGE. DOUBLE CHECK THAT ALL BOLTS ARE SECURELY TIGHTENED PRIOR TO USE.

VI. MAINTENANCE/CARE

1. Inspect all parts and related hardware periodically. Replace all hardware that appears rusted or deformed.
2. Inspect all nuts and bolts. Tighten all nuts that appear to be loose. Stripped, fractured, or bent bolts or nuts need to be replaced.
moving or rotating parts. Remove debris that may inhibit the part from moving freely.